

Programmation Parallèle

MPI: Message Passing Interface

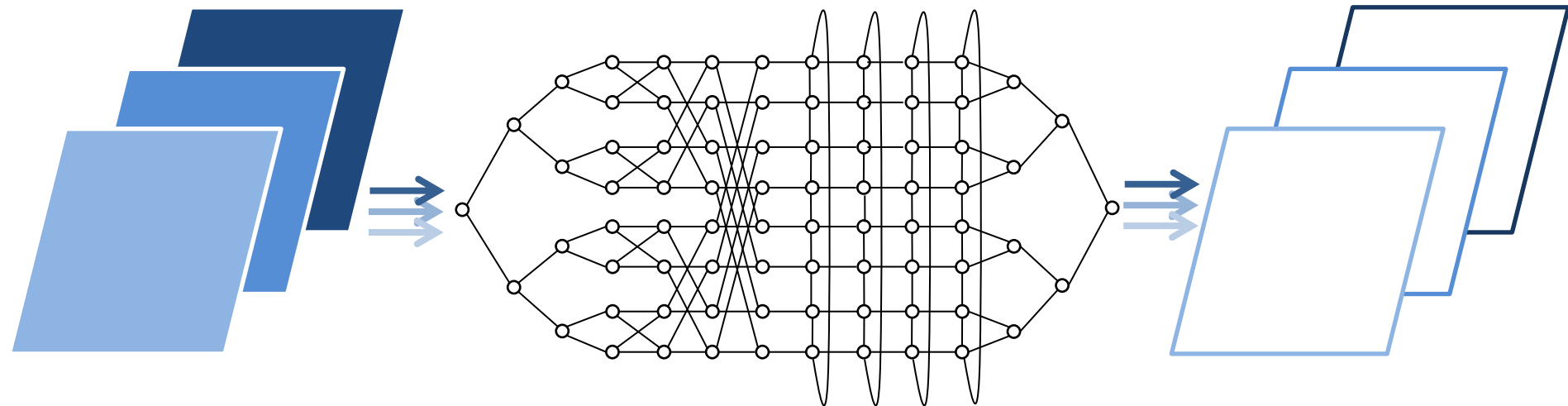

MPI I/O

Parallel file reading/writing

ENSIIE-HPC/BigData-PP-IPAR-Lecture 5

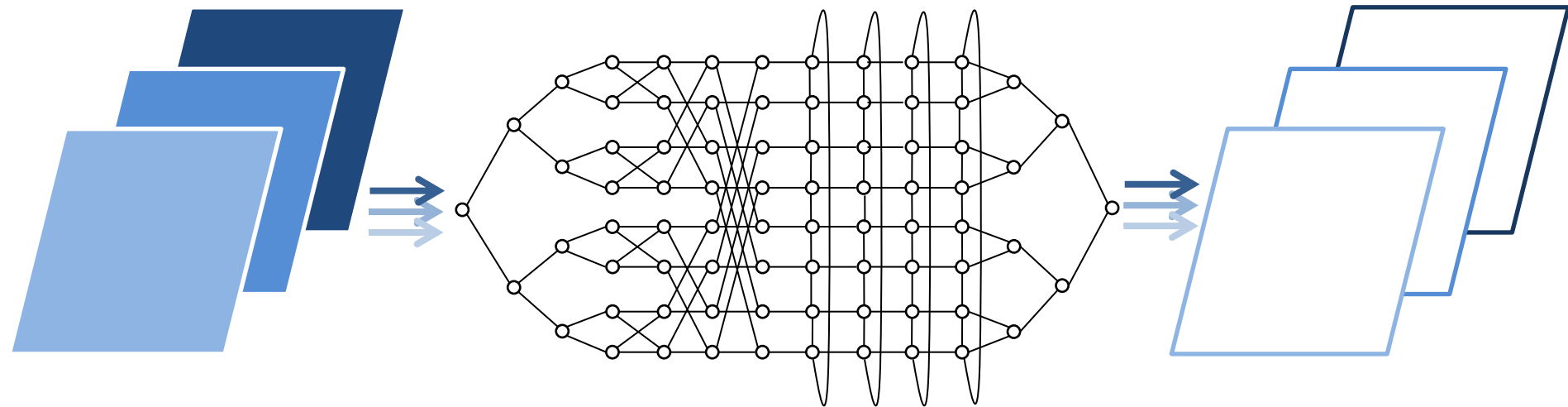

INTRODUCTION ON I/O

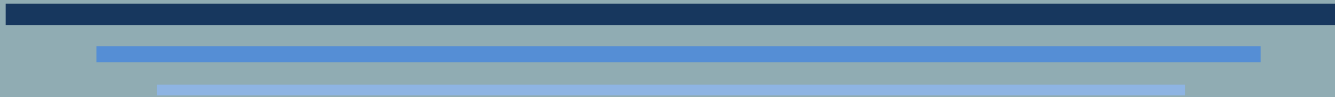

What are I/O ?



- I/O stands for Input/Output
- I/O usually regroups every operations applied on files by a program
 - Reading (Input)
 - Writing (Output)
 - File Management
 - Resizing
 - Splitting/Merging
 - Organizing
 - Searching

Why do we need I/O ?



- Simulations produce lot of data
 - Not meant to be directly read by a person
 - Necessary to
 - Directly translate them into human readable objects (pictures,...)
 - Store the data to be read by another “translator” program (visualizer,...)
- These data need to be stored
 - To be used by other programs
 - To keep history of simulations
 - You don't want to replay the simulation any time you need some result
- Checkpoint/restart
 - More complex supercomputer means more failures
 - Mean time before failure (mtbf) less than some simulations time
 - Necessary to save temporary states to restart the simulation

Sequential I/O



- Original paradigm
 - Example: Posix I/O
- How to do I/O?



Sequential I/O

- Original paradigm
 - Example: Posix I/O
- How to do I/O?
 - Process P1 open a file handler
 - Associated with a name

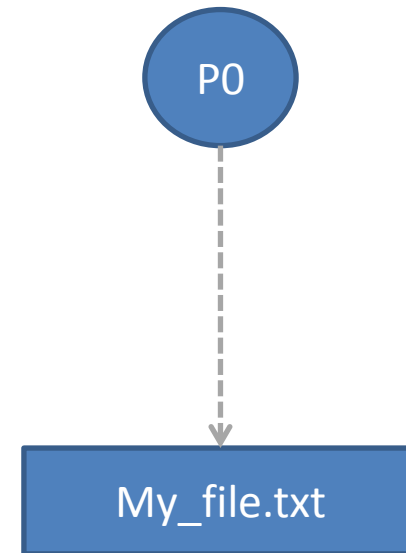

Sequential I/O

- Original paradigm
 - Example: Posix I/O
- How to do I/O?
 - Process P1 open a file handler
 - Associated with a name
 - May create it if it does not already exist
 - P1 either read data....

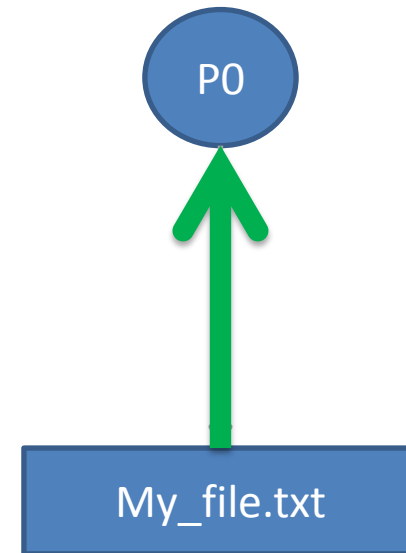

Sequential I/O

- Original paradigm
 - Example: Posix I/O
- How to do I/O?
 - Process P1 open a file handler
 - Associated with a name
 - May create it if it does not already exist
 - P1 either read data....
 - ... or write data

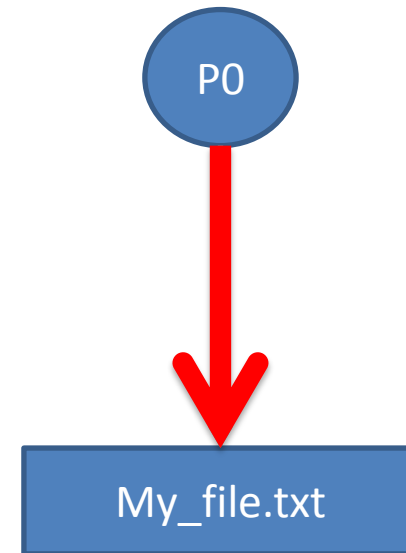

Sequential I/O

- Original paradigm

- Example: Posix I/O

- How to do I/O?

- Process P1 open a file handler
 - Associated with a name
 - May create it if it does not already exist
- P1 either read data....
- ... or write data
- Once it is done

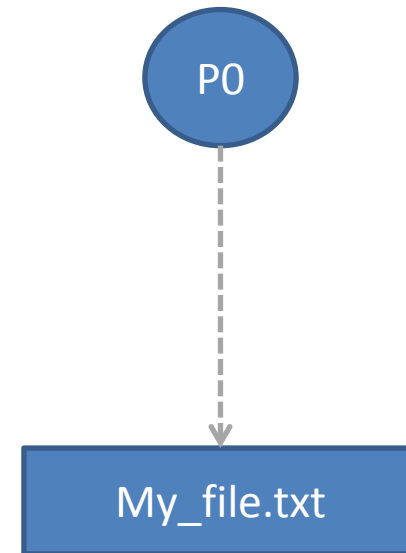

Sequential I/O

- Original paradigm

- Example: Posix I/O

- How to do I/O?

- Process P1 open a file handler
 - Associated with a name
 - May create it if it does not already exist
- P1 either read data....
- ... or write data
- Once it is done, P1 close file handler

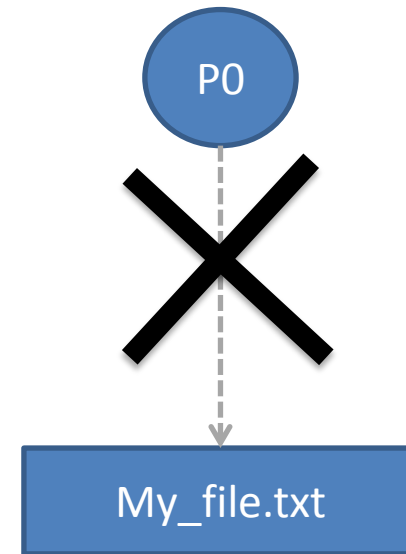

Sequential I/O

- Original paradigm

- Example: Posix I/O

- How to do I/O?

- Process P1 open a file handler
 - Associated with a name
 - May create it if it does not already exist
- P1 either read data....
- ... or write data
- Once it is done, P1 close file handler

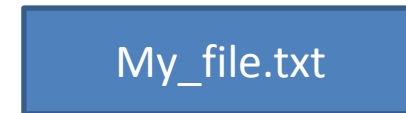

Sequential I/O

- Original paradigm

- Example: Posix I/O

- How to do I/O?

- Process P1 open a file handler
 - Associated with a name
 - May create it if it does not already exist
- P1 either read data....
- ... or write data
- Once it is done, P1 close file handler
 - May also delete the file if asked

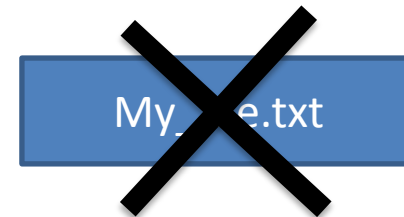

Parallel I/O



- Easy when there is only one process
- How to manage that with multiple processes which all want to read/write?
- Solution:
 - One-to-One
 - All-to-All
 - One-to-All
 - All-to-One

Parallel One-to-One I/O

- Based on legacy sequential I/O
 - One process manage the I/Os (Open File handler, read, write)

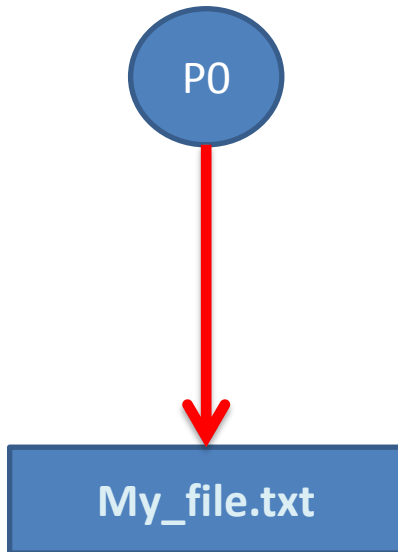

Parallel One-to-One I/O

- Based on legacy sequential I/O
 - One process manage the I/Os (Open File handler, read, write)
- The other processes “delegate” their I/Os to the chosen one

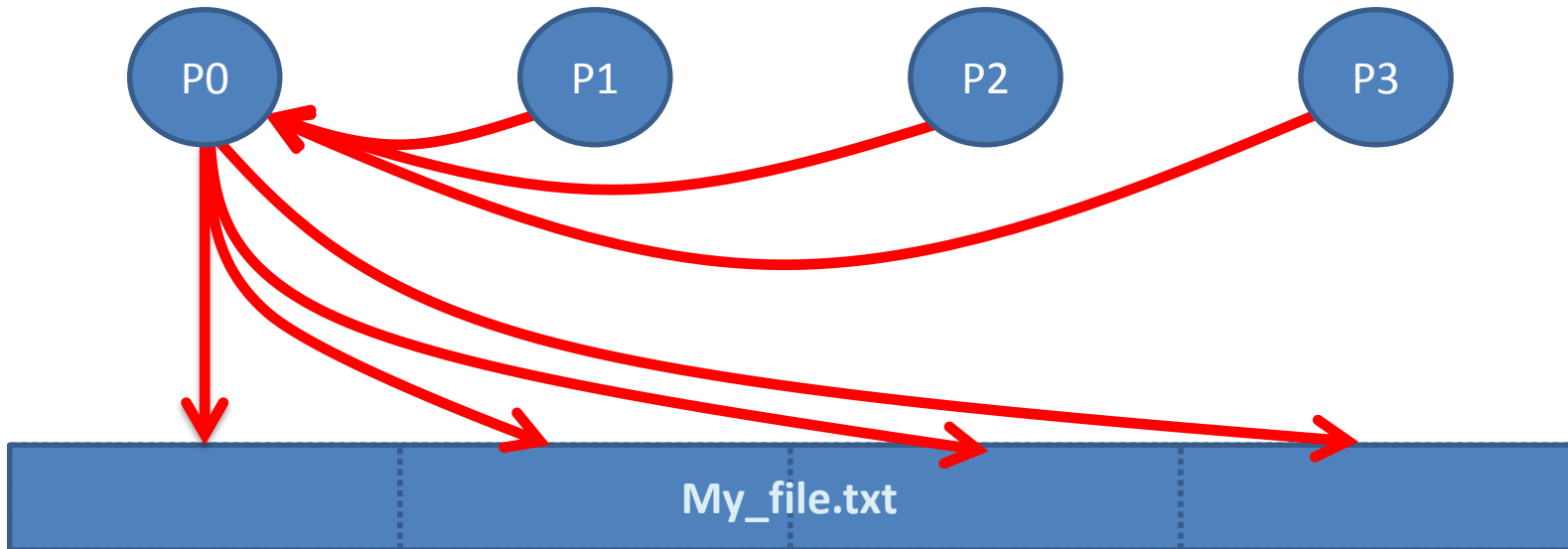

Parallel One-to-One I/O

- Based on legacy sequential I/O
 - One process manage the I/Os (Open File handler, read, write)
- The other processes “delegate” their I/Os to the chosen one
 - ✓ Fit for parallel systems and I/O library not supporting parallel I/O
 - ✓ Only one result file: easy to read, to move...
 - ✗ No parallelism: poor scalability -> poor performances

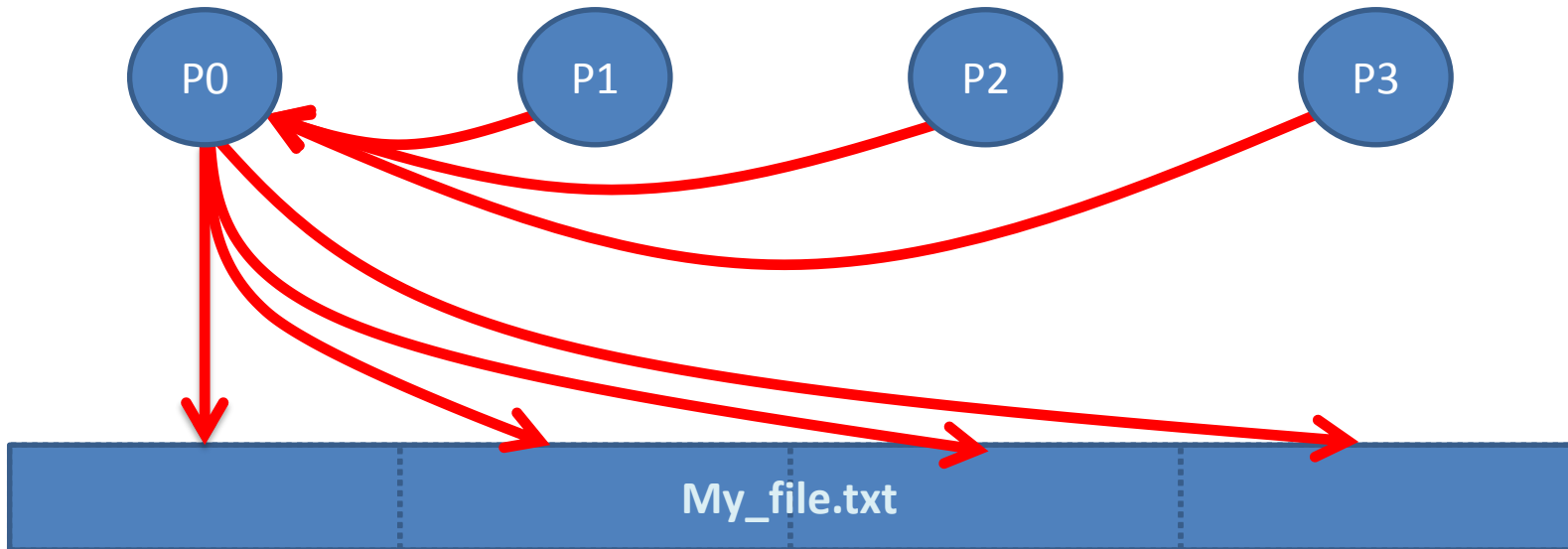

Parallel All-to-All I/O

- Based on legacy sequential I/O
 - One process manages its own I/O

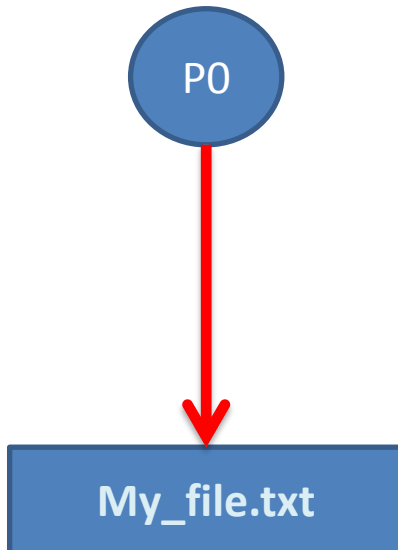

Parallel All-to-All I/O

- Based on legacy sequential I/O
 - One process manages its own I/O
- Every process only manages its own handler file

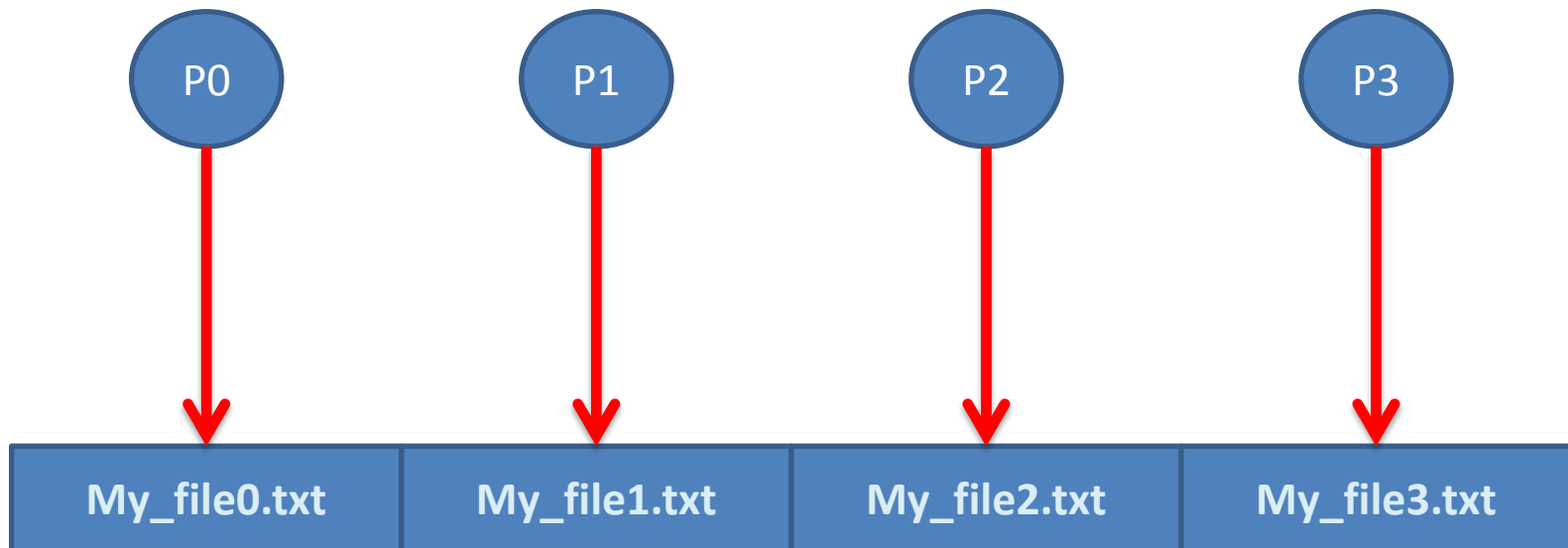

Parallel All-to-All I/O

- Based on legacy sequential I/O
 - One process manages its own I/O
- Every process only manages its own handler file
 - ✓ Parallelism: no bottlenecks on processes
 - ✗ Lots of small files to manages
 - ✗ Difficult to read back from different number of processes

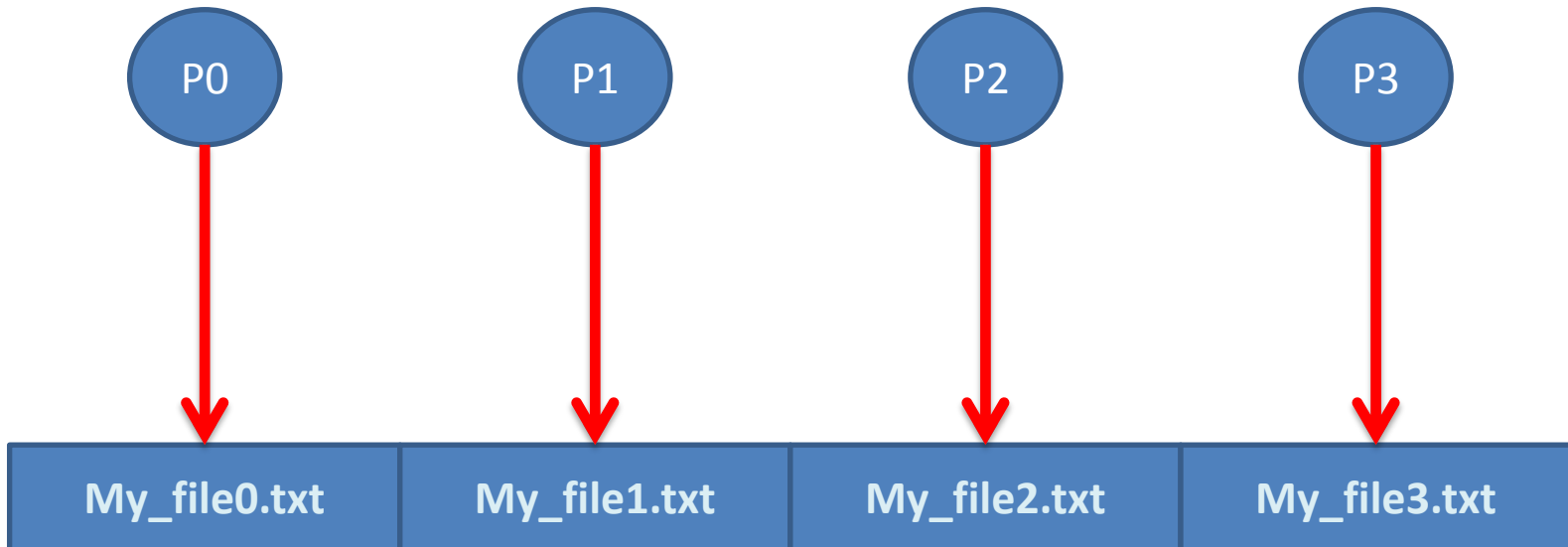

Parallel One-to-All I/O

- One process manage the I/Os (Open File handler, read, write)
- The other processes “delegate” their I/Os to the chosen one
- The I/Os are spread across multiple files

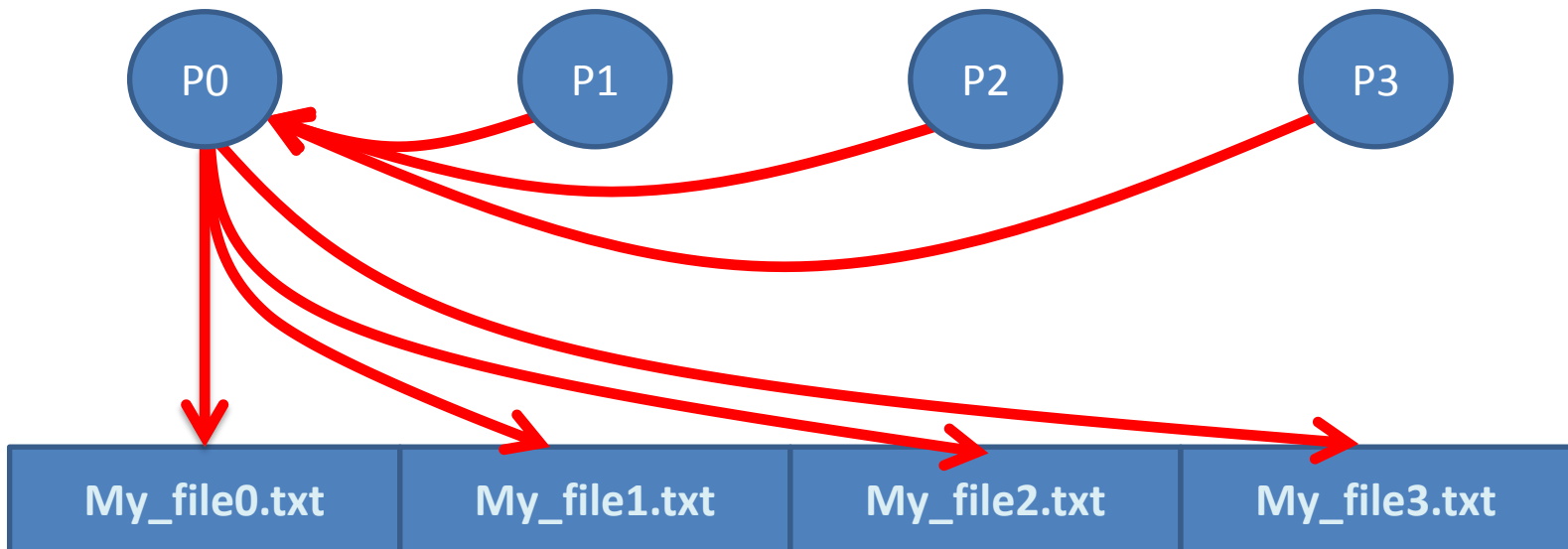

Parallel One-to-All I/O

- One process manage the I/Os (Open File handler, read, write)
- The other processes “delegate” their I/Os to the chosen one
- The I/Os are spread across multiple files
 - ❌ Bottleneck on the I/O manager process
 - ❌ Multiple file handlers to manage by chosen process
 - ❌ Multiple result files to manage

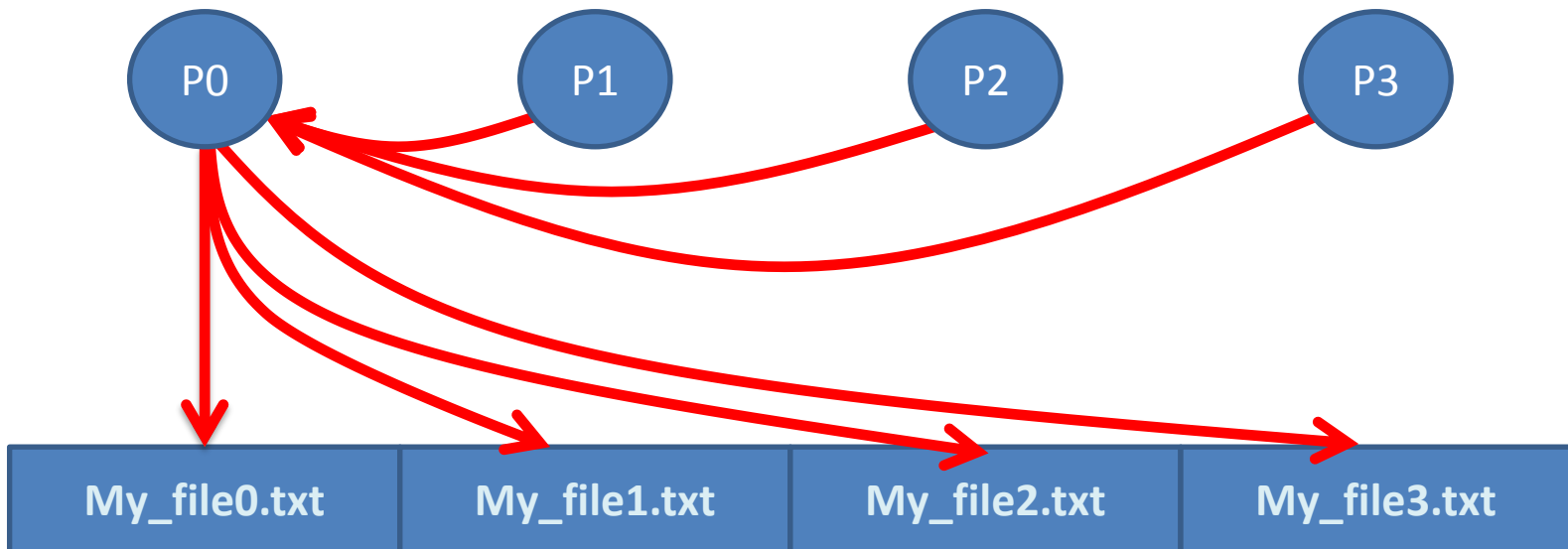

Parallel One-to-All I/O

- One process manage the I/Os (Open, Read, Write, Close)
- The other processes “delegate” I/Os to the first process
- The I/Os are spread across all processes

❌ Bottlenecked

❌ Multiple

❌

YOU DON'T WANT TO DO THAT!

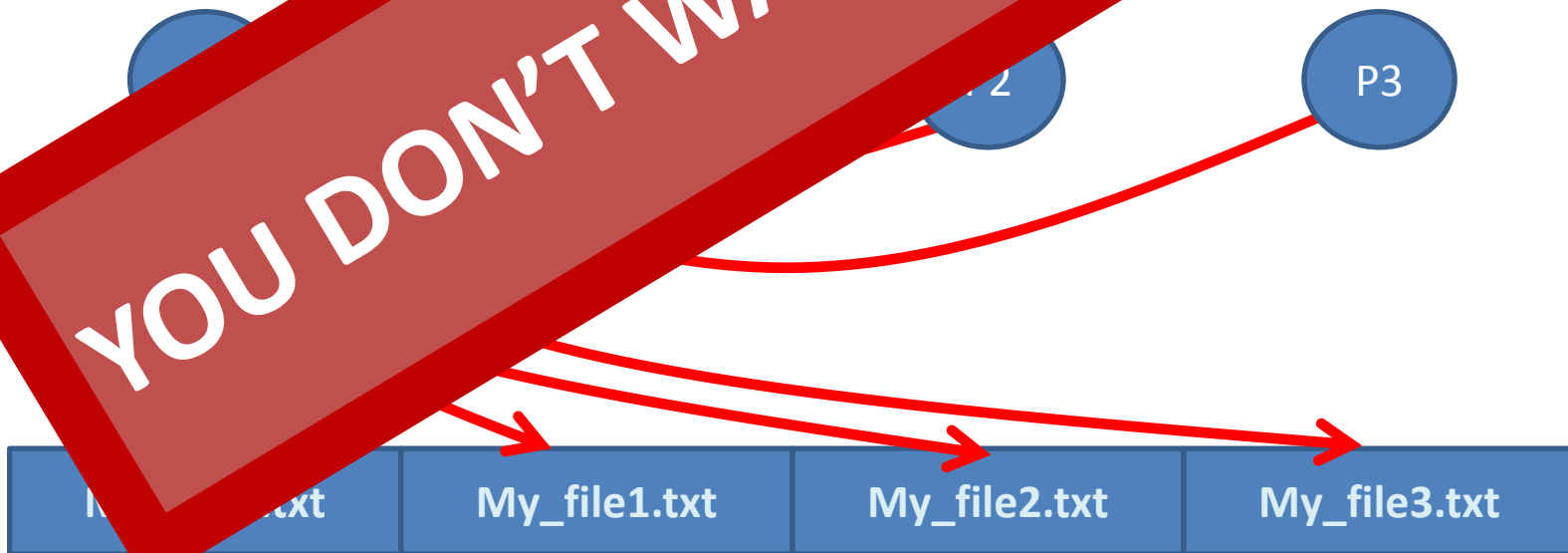

Parallel All-to-one I/O

- Every process manages its own I/Os
- Cooperative access to the same file to write data in parallel

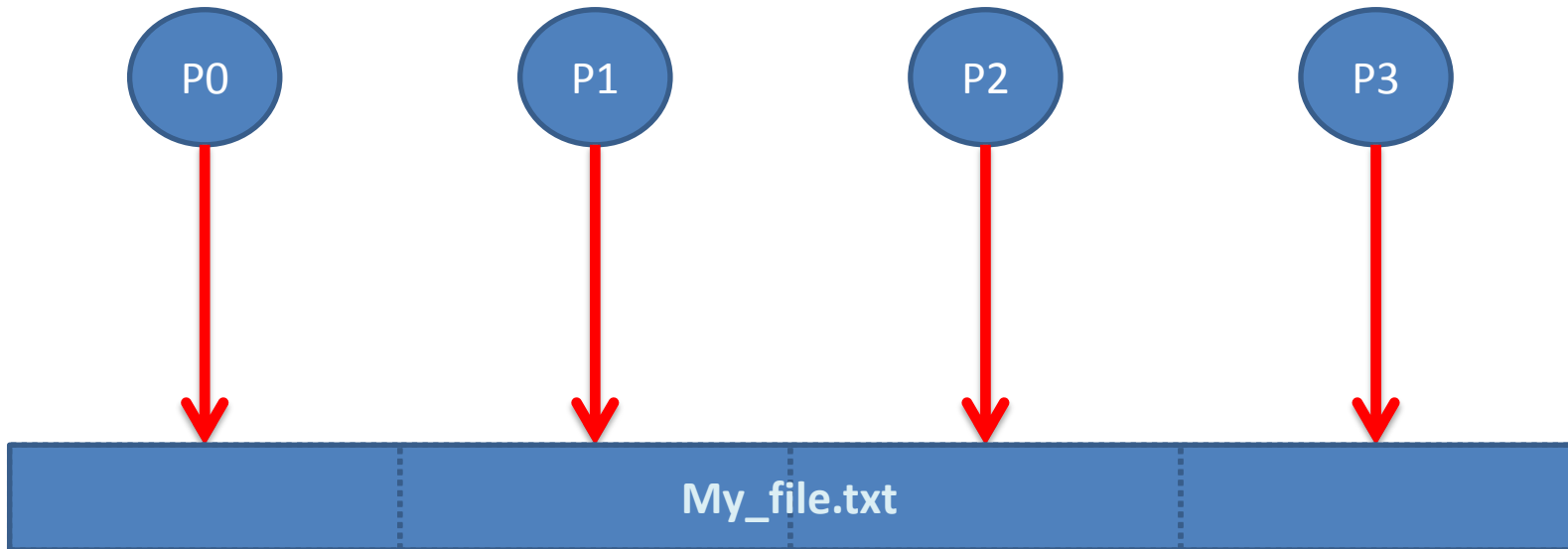

Parallel All-to-one I/O

- Every process manages its own I/Os
- Cooperative access to the same file to write data in parallel
 - ✓ Parallelism: no bottlenecks on processes
 - ✓ Only one result file to manage
 - ✗ /!\ ordering when multiple processes are writing to the same address

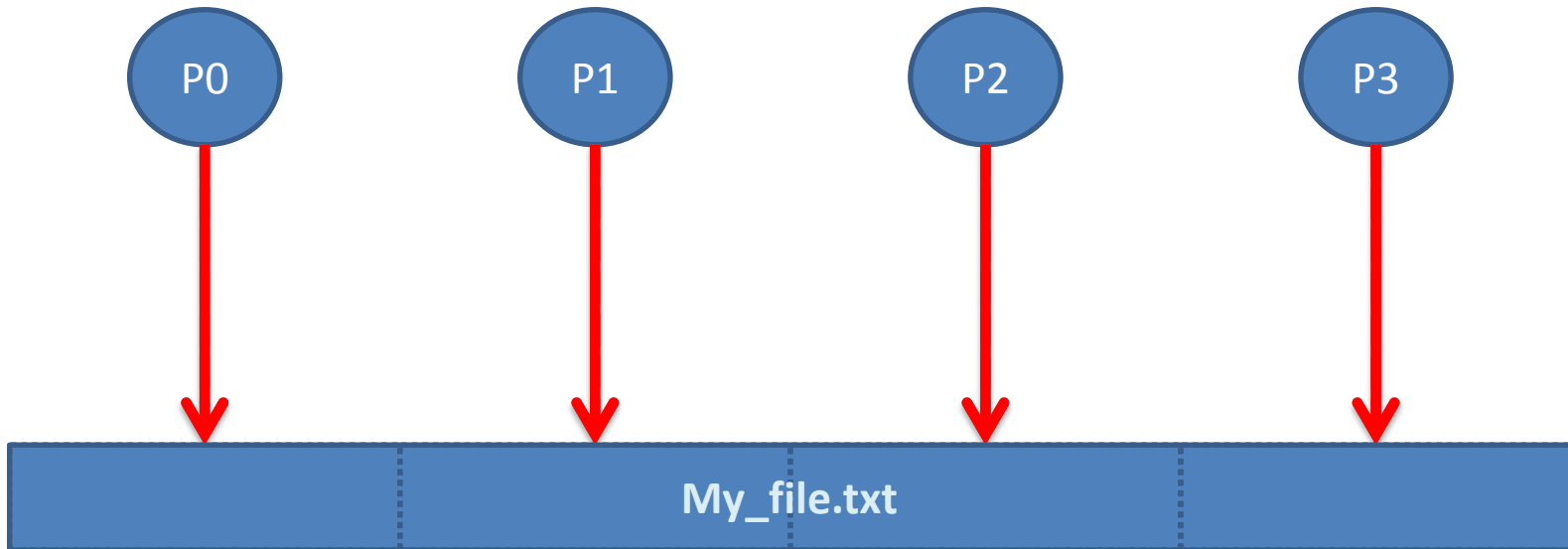

Parallel All-to-one I/O

- Every process manages its own I/Os
- Cooperative access to the same file to write data in parallel
 - ✓ Parallelism: no bottlenecks on processes
 - ✓ Only one result file to manage
 - ✗ /!\ ordering when multiple processes are writing to the same address
 - ✓ If handled correctly, all processes should be able to write all over the file

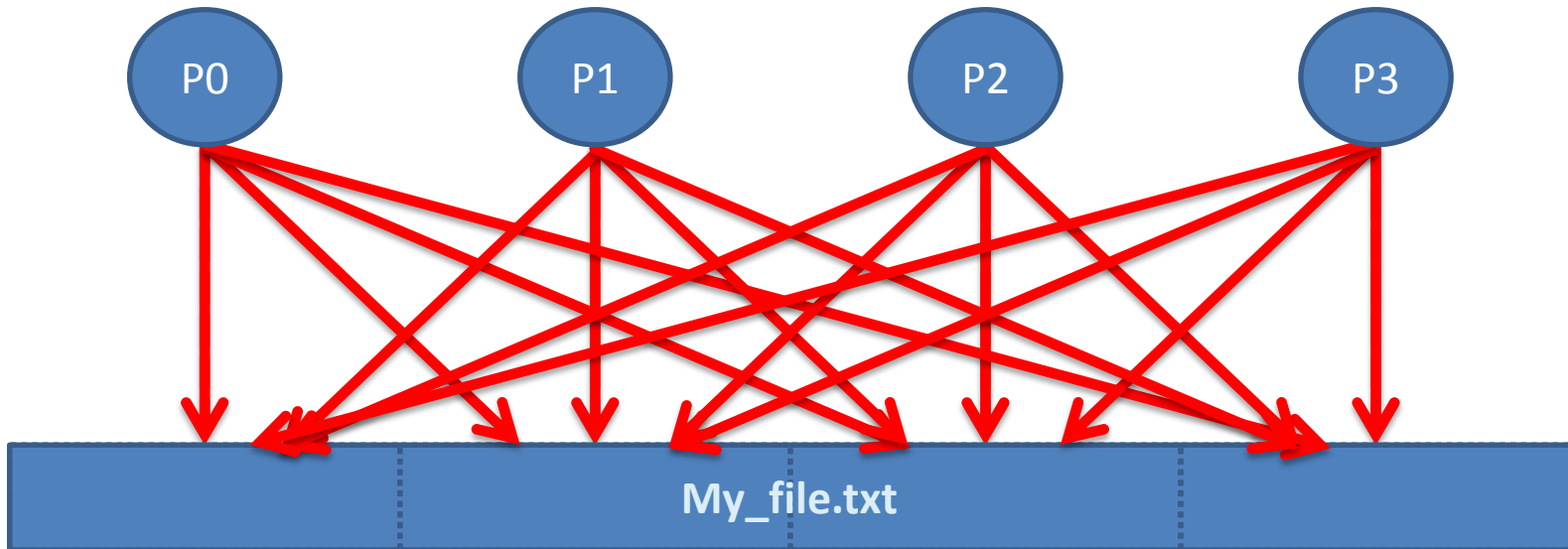

Parallel All-to-one I/O

- Every process manages its own I/O
- Cooperative access to the same file
 - ✓ Parallelism: no bottlenecks
 - ✓ Only one read/write per process
 - ✗ /!\ order of writes is not guaranteed
 - ✓ If processes write to the same address, they will overwrite each other
 - ✓ If processes write to different addresses, they will not overwrite each other

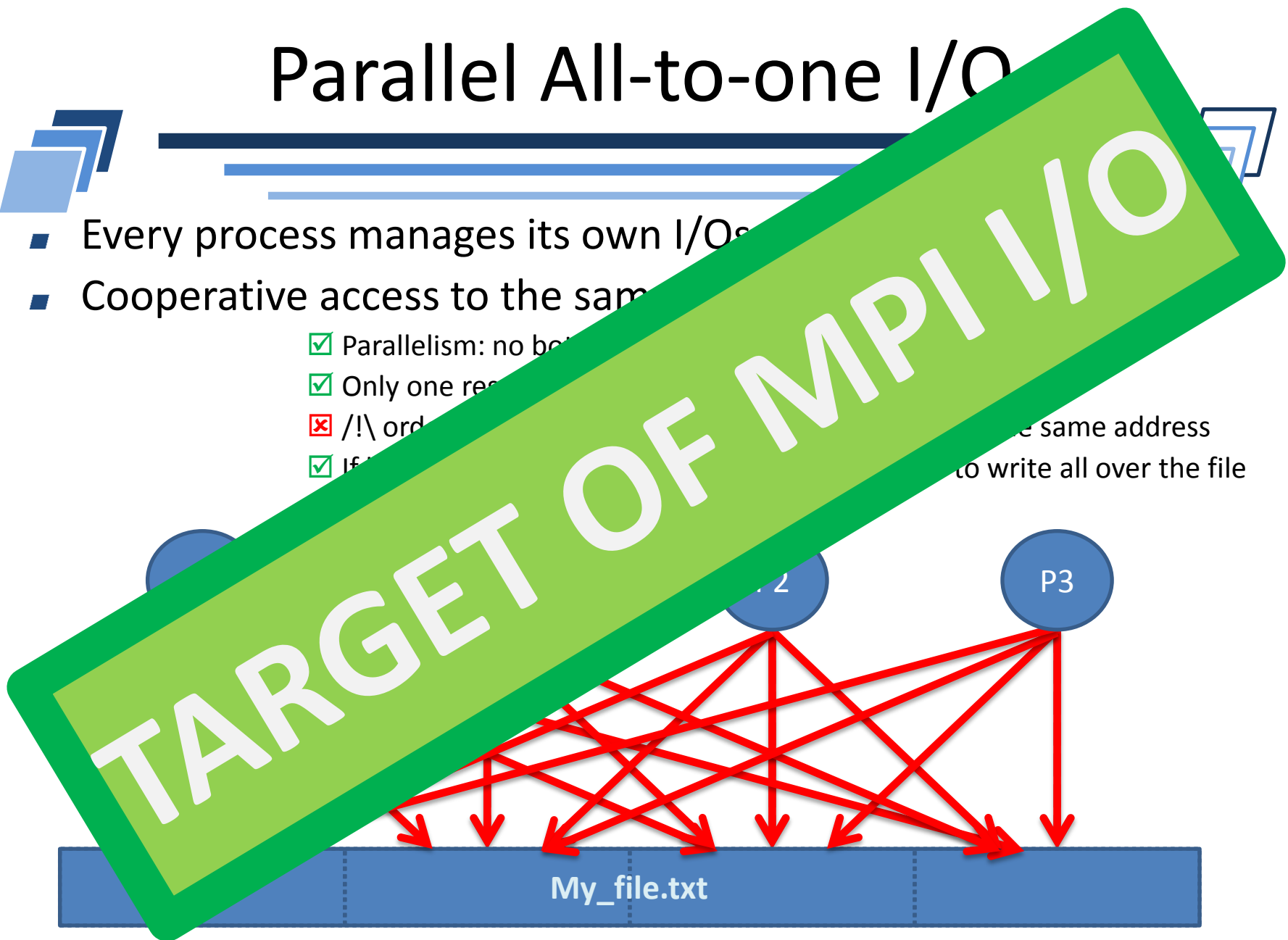

MPI I/O VIEW SYSTEM

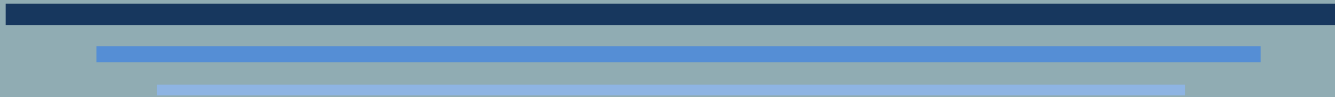

What are MPI I/O views?



- MPI I/O targets the One-to-All parallel I/O model
 - Each process should be able to write anywhere in the file
- Problem with this model: race conditions if multiple processes try to write at the same address
 - At least contention if they try to read the same address
- Each MPI process should have its own accessible area
- A *view* defines, for a process, the current set of data visible and accessible from an open file

MPI I/O definitions: etype



- **etype**: An *etype* (*elementary datatype*) is the unit of data access and positioning
 - From MPI I/O point of view, a file is a contiguous set of etypes

MPI I/O definitions: etype



- **etype**: An *etype* (*elementary* datatype) is the unit of data access and positioning
 - From MPI I/O point of view, a file is a contiguous set of etypes
- Example: consider the following memory area of a file



MPI I/O definitions: etype

- **etype**: An *etype* (*elementary datatype*) is the unit of data access and positioning
 - From MPI I/O point of view, a file is a contiguous set of etypes

- Example: consider the following memory area of a file



- if etypes=MPI_DOUBLE, this file is composed of 9 elements



MPI I/O definitions: etype

- **etype**: An *etype* (*elementary datatype*) is the unit of data access and positioning
 - From MPI I/O point of view, a file is a contiguous set of etypes

- Example: consider the following memory area of a file



- if etypes=MPI_DOUBLE, this file is composed of 9 elements



- If etypes=MPI_FLOAT, the same file is composed of 18 elements



MPI I/O definitions: filetype



- **filetype**: A *filetype* is the basis for partitioning a file among processes and defines a template for accessing the file. A filetype is either a single etype, or a derived MPI datatype constructed from multiple instances of the same etype (including the holes).

MPI I/O definitions: filetype



- **filetype**: A *filetype* is the basis for partitioning a file among processes and defines a template for accessing the file. A filetype is either a single etype, or a derived MPI datatype constructed from multiple instances of the same etype (including the holes).
- Example: consider the following etype:



MPI I/O definitions: filetype

- **filetype**: A *filetype* is the basis for partitioning a file among processes and defines a template for accessing the file. A filetype is either a single etype, or a derived MPI datatype constructed from multiple instances of the same etype (including the holes).
- Example: consider the following etype:



- An example of filetype constructed from this etype:

Data accessible in the view



Holes: data ignored in the view

MPI I/O definitions: displacement



- **displacement**: A file *displacement* is an absolute byte position relative to the beginning of a file. The displacement defines the location where a view begins.

MPI I/O definitions: displacement



- **displacement**: A file *displacement* is an absolute byte position relative to the beginning of a file. The displacement defines the location where a view begins.
- Example: consider the following memory area of a file



MPI I/O definitions: displacement

- **displacement**: A file *displacement* is an absolute byte position relative to the beginning of a file. The displacement defines the location where a view begins.

- Example: consider the following memory area of a file



- Example of displacement

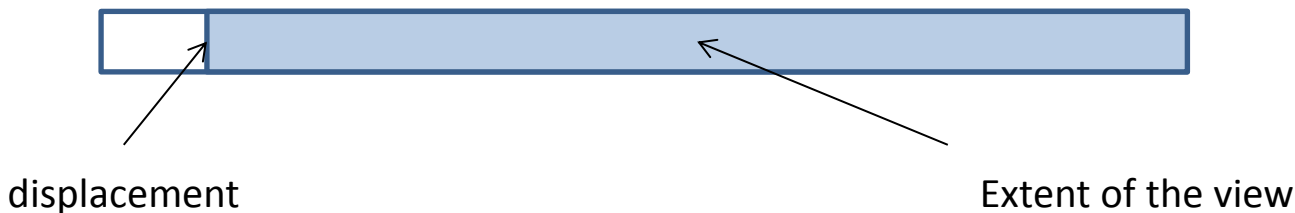

MPI I/O definitions: view



- **view**: A *view* is defined by three quantities: a displacement, an etype and a filetype. The pattern described by the filetype is repeated, beginning at the displacement, to define the complete view.

MPI I/O definitions: view



- **view**: A *view* is defined by three quantities: a displacement, an etype and a filetype. The pattern described by the filetype is repeated, beginning at the displacement, to define the complete view.
- Example from the MPI standard (Chapter 13 MPI I/O)

MPI I/O definitions: view



- **view**: A *view* is defined by three quantities: a displacement, an etype and a filetype. The pattern described by the filetype is repeated, beginning at the displacement, to define the complete view.
- Example from the MPI standard (Chapter 13 MPI I/O)
 - etype:

MPI I/O definitions: view

- **view**: A *view* is defined by three quantities: a displacement, an etype and a filetype. The pattern described by the filetype is repeated, beginning at the displacement, to define the complete view.

- Example from the MPI standard (Chapter 13 MPI I/O)

- etype: 

- filetype:



MPI I/O definitions: view

- **view**: A *view* is defined by three quantities: a displacement, an etype and a filetype. The pattern described by the filetype is repeated, beginning at the displacement, to define the complete view.

- Example from the MPI standard (Chapter 13 MPI I/O)

- etype: 

- filetype: 

- file 

MPI I/O definitions: view

- **view**: A *view* is defined by three quantities: a displacement, an etype and a filetype. The pattern described by the filetype is repeated, beginning at the displacement, to define the complete view.

- Example from the MPI standard (Chapter 13 MPI I/O)

- etype: 

- filetype:



- file





- displacement: 8

MPI I/O definitions: view

- **view**: A *view* is defined by three quantities: a displacement, an etype and a filetype. The pattern described by the filetype is repeated, beginning at the displacement, to define the complete view.

- Example from the MPI standard (Chapter 13 MPI I/O)

- etype: 

- filetype: 

- file: 

- displacement: 8

- **view**:



MPI I/O definitions: view

- **view**: A *view* is defined by three quantities: a displacement, an etype and a filetype. The pattern described by the filetype is repeated, beginning at the displacement, to define the complete view.

- Example from the MPI standard (Chapter 13 MPI I/O)

- etype: 

- filetype: 

- file: 

- displacement: 8

- **view**:



MPI I/O definitions: view

- **view**: A *view* is defined by three quantities: a displacement, an etype and a filetype. The pattern described by the filetype is repeated, beginning at the displacement, to define the complete view.

- Example from the MPI standard (Chapter 13 MPI I/O)

- etype: 

- filetype: 

- file: 

- displacement: 8

- **view**:



Sharing a file



- A group of processes sharing the same file may use complementary views to achieve a global data distributio

Sharing a file



- A group of processes sharing the same file may use complementary views to achieve a global data distribution
- Example from the MPI standard (Chapter 13 MPI I/O)

Sharing a file

- A group of processes sharing the same file may use complementary views to achieve a global data distribution
- Example from the MPI standard (Chapter 13 MPI I/O)
 - etype:

Sharing a file



- A group of processes sharing the same file may use complementary views to achieve a global data distribution
- Example from the MPI standard (Chapter 13 MPI I/O)
 - etype:
 - Process 0 filetype:

| | | | | | |
|--|--|--|--|--|--|
| | | | | | |
|--|--|--|--|--|--|

Sharing a file



- A group of processes sharing the same file may use complementary views to achieve a global data distribution
- Example from the MPI standard (Chapter 13 MPI I/O)
 - etype:
 - Process 0 filetype:

| | | | | | |
|--|--|--|--|--|--|
| | | | | | |
|--|--|--|--|--|--|
 - Process 1 filetype:

| | | | | | |
|--|--|--|--|--|--|
| | | | | | |
|--|--|--|--|--|--|

Sharing a file

- A group of processes sharing the same file may use complementary views to achieve a global data distribution

- Example from the MPI standard (Chapter 13 MPI I/O)

- etype:

- Process 0 filetype: 

- Process 1 filetype: 

- Process 2 filetype: 

Sharing a file

- A group of processes sharing the same file may use complementary views to achieve a global data distribution

- Example from the MPI standard (Chapter 13 MPI I/O)

- etype:

- Process 0 filetype: 

- Process 1 filetype: 

- Process 2 filetype: 

- Data covered by all the views:



Sharing a file

- A group of processes sharing the same file may use complementary views to achieve a global data distribution

- Example from the MPI standard (Chapter 13 MPI I/O)

- etype:

- Process 0 filetype:

| | | | | | |
|--|--|--|--|--|--|
| | | | | | |
|--|--|--|--|--|--|

- Process 1 filetype:

| | | | | | |
|--|--|--|--|--|--|
| | | | | | |
|--|--|--|--|--|--|

- Process 2 filetype:

| | | | | | |
|--|--|--|--|--|--|
| | | | | | |
|--|--|--|--|--|--|

- Data covered by all the views:



Sharing a file

- A group of processes sharing the same file may use complementary views to achieve a global data distribution

- Example from the MPI standard (Chapter 13 MPI I/O)

- etype:

- Process 0 filetype:

| | | | | | |
|--|--|--|--|--|--|
| | | | | | |
|--|--|--|--|--|--|

- Process 1 filetype:

| | | | | | |
|--|--|--|--|--|--|
| | | | | | |
|--|--|--|--|--|--|

- Process 2 filetype:

| | | | | | |
|--|--|--|--|--|--|
| | | | | | |
|--|--|--|--|--|--|

- Data covered by all the views:



Sharing a file

- A group of processes sharing the same file may use complementary views to achieve a global data distribution

- Example from the MPI standard (Chapter 13 MPI I/O)

- etype:

- Process 0 filetype:

| | | | | | |
|--|--|--|--|--|--|
| | | | | | |
|--|--|--|--|--|--|

- Process 1 filetype:

| | | | | | |
|--|--|--|--|--|--|
| | | | | | |
|--|--|--|--|--|--|

- Process 2 filetype:

| | | | | | |
|--|--|--|--|--|--|
| | | | | | |
|--|--|--|--|--|--|

- Data covered by all the views:



BUILDING FILETYPES

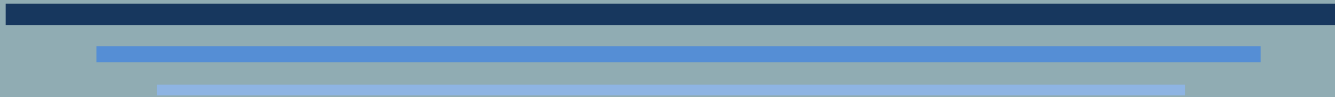

Building filetypes with holes



- Filetypes are datatypes, and they can be build from with any datatype constructors, as long as it follows these rules:
 - Filetypes are only composed of a single datatype (etype)
 - Holes in the datatypes are multiple of the extent of this etype
- However, from functions seen in PP-C3, we can only build datatypes with no holes at the beginning and the end
- How to build the filetypes from the MPI standard example?

Resizing datatypes



- `MPI_Type_create_resized(MPI_Datatype oldtype, MPI_Aint lb, MPI_Aint extent, MPI_Datatype *newtype);`
 - IN oldtype input datatype (handle)
 - IN lb new lower bound of datatype (integer)
 - IN extent new extent of datatype (integer)
 - OUT newtype output datatype (handle)
- `MPI_Type_create_resized` takes an old datatype and changes the lower bound and the size
- To insert holes before the datatype, lower bound must be negative
- To insert holes after the datatype, extent must be greater than the original datatype size.
- Lower bound and extent are given in bytes

Example from MPI I/O chapter





```
MPI_Datatype datatmp, filetype;  
MPI_Type_contiguous(2, MPI_INT, &datatmp)  
MPI_Aint lower_bound=-1*sizeof(int)  
MPI_Aint extent = 6*sizeof(int)  
MPI_Type_create_resized(datatmp, lower_bound, extent, &filetype);  
MPI_Type_commit(&filetype);
```

■ oldtype = int 



Example from MPI I/O chapter

```
MPI_Datatype datatmp, filetype;  
MPI_Type_contiguous(2, MPI_INT, &datatmp)  
MPI_Aint lower_bound=-1*sizeof(int)  
MPI_Aint extent = 6*sizeof(int)  
MPI_Type_create_resized(datatmp, lower_bound, extent, &filetype);  
MPI_Type_commit(&filetype);
```

- oldtype = int 
- datatmp: 





Example from MPI I/O chapter

```
MPI_Datatype datatmp, filetype;
MPI_Type_contiguous(2, MPI_INT, &datatmp)
MPI_Aint lower_bound=-1*sizeof(int)
MPI_Aint extent = 6*sizeof(int)
MPI_Type_create_resized(datatmp, lower_bound, extent, &filetype);
MPI_Type_commit(&filetype);
```

- oldtype = int 
- datatmp: 
- datatmp + lower_bound: 

Example from MPI I/O chapter

```
MPI_Datatype datatmp, filetype;  
MPI_Type_contiguous(2, MPI_INT, &datatmp)  
MPI_Aint lower_bound=-1*sizeof(int)  
MPI_Aint extent = 6*sizeof(int)  
MPI_Type_create_resized(datatmp, lower_bound, extent, &filetype);  
MPI_Type_commit(&filetype);
```

- oldtype = int 
- datatmp: 
- datatmp + lower_bound: 
- filetype: 

FILE MANAGEMENT

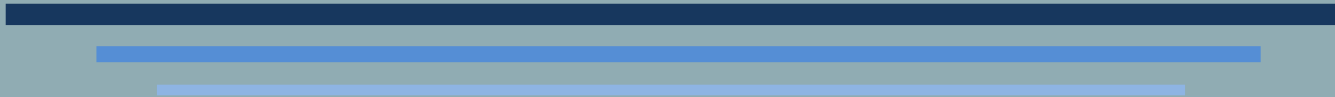

Opening a file



- `MPI_File_open(MPI_Comm comm, const char *filename, int amode, MPI_Info info, MPI_File *fh);`
 - IN comm communicator (handle)
 - IN filename name of file to open (string)
 - IN amode file access mode (integer)
 - IN info info object (handle)
 - OUT fh new file handle (handle)
- Collective function
 - Each process must specify same amode, and referencing the same file
- Amode defines the access mode when opening the file
 - Read only, write only, read-write,...
- When opening a file, the default view is a linear byte stream
 - Displacement=0, etype=filetype=MPI_BYTE)

Available amode



- `MPI_MODE_RDONLY` : file will only be read
- `MPI_MODE_RDWR` : file will be read and written
- `MPI_MODE_WRONLY` : file will only be written
- `MPI_MODE_CREATE` : file is created if it does not exist
- `MPI_MODE_EXCL` : error if creating file that already exists
- `MPI_MODE_DELETE_ON_CLOSE` : delete file when closing the file handler
- `MPI_MODE_UNIQUE_OPEN` : file will not be concurrently opened elsewhere,
- `MPI_MODE_SEQUENTIAL` : file will only be accessed sequentially
- `MPI_MODE_APPEND` : set initial position of all file pointers to end of file

Changing file view

- `MPI_File_set_view(MPI_File fh, MPI_Offset disp, MPI_Datatype etype, MPI_Datatype filetype, const char *datarep, MPI_Info info);`
 - INOUT fh file handle (handle)
 - IN disp displacement (integer)
 - IN etype elementary datatype (handle)
 - IN filetype filetype (handle)
 - IN datarep data representation (string)
 - IN info info object (handle)
- Attach a new view to an opened file
- Collective function
 - Each process must specify same etype and datarep
- Datarep specify how the data will be written in memory
 - Native, internal and extern32

Closing and deleting file



- `MPI_File_close(MPI_File *fh);`
- Close the specified file handler
 - If file was opened with `MPI_MODE_DELETE_ON_CLOSE`, file is deleted
- Collective function

- `MPI_File_delete(const char *filename, MPI_Info info);`
- Delete the specified file
 - If file does not exist, an error class `MPI_ERR_NO_SUCH_FILE` is raised

READING AND WRITING ROUTINES

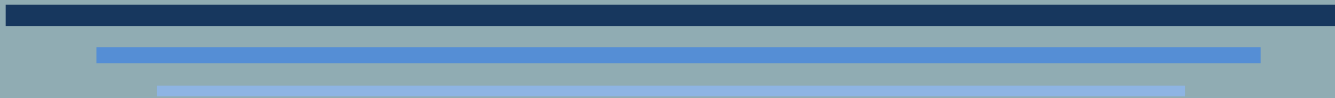

Individual read

- `MPI_File_read(MPI_File fh, void *buf, int count, MPI_Datatype datatype, MPI_Status *status);`
 - INOUT fh file handle (handle)
 - OUT buf initial address of buffer to put read data
 - IN count number of elements in buffer (integer)
 - IN datatype datatype of each buffer element (handle)
 - OUT status status object (Status)
- Individual function
- *count* and *datatype* specifies the number of elements and the type of elements to read and put in buffer *buf*
 - Much like in a `MPI_Recv` function
- Read contiguous elements according to the view associated with the file

individual reading example



```
/*filetype from previous example "sharing a file"*/
```

```
MPI_Type_create_resized(datatmp, lower_bound, extent, &filetype);
```

```
MPI_Type_commit(&filetype);
```

```
Int buf[7];
```

```
MPI_File_read(fh, &buf, 7, MPI_INT, MPI_STATUS_IGNORE);
```

■ File:

| | | | | | | | | | | | | | | | | | | | | | | | |
|---|---|---|---|---|---|---|---|---|----|----|----|----|----|----|----|----|----|----|----|----|----|----|----|
| 1 | 2 | 3 | 4 | 5 | 6 | 7 | 8 | 9 | 10 | 11 | 12 | 13 | 14 | 15 | 16 | 17 | 18 | 19 | 20 | 21 | 22 | 23 | 24 |
|---|---|---|---|---|---|---|---|---|----|----|----|----|----|----|----|----|----|----|----|----|----|----|----|

individual reading example

/*filetype from previous example "sharing a file"*/

```
MPI_Type_create_resized(datatmp, lower_bound, extent, &filetype);
```

```
MPI_Type_commit(&filetype);
```

```
Int buf[7];
```

```
MPI_File_read(fh, &buf, 7, MPI_INT, MPI_STATUS_IGNORE);
```

- File:

| | | | | | | | | | | | | | | | | | | | | | | | |
|---|---|---|---|---|---|---|---|---|----|----|----|----|----|----|----|----|----|----|----|----|----|----|----|
| 1 | 2 | 3 | 4 | 5 | 6 | 7 | 8 | 9 | 10 | 11 | 12 | 13 | 14 | 15 | 16 | 17 | 18 | 19 | 20 | 21 | 22 | 23 | 24 |
|---|---|---|---|---|---|---|---|---|----|----|----|----|----|----|----|----|----|----|----|----|----|----|----|
- View:

| | | | | | | | | | | | | | | | | | | | | | | | |
|--|--|--|--|--|--|--|--|--|--|--|--|--|--|--|--|--|--|--|--|--|--|--|--|
| | | | | | | | | | | | | | | | | | | | | | | | |
|--|--|--|--|--|--|--|--|--|--|--|--|--|--|--|--|--|--|--|--|--|--|--|--|
- To read: 7 MPI_INT

individual reading example

/*filetype from previous example "sharing a file"*/

```
MPI_Type_create_resized(datatmp, lower_bound, extent, &filetype);
```

```
MPI_Type_commit(&filetype);
```

```
Int buf[7];
```

```
MPI_File_read(fh, &buf, 7, MPI_INT, MPI_STATUS_IGNORE);
```

- File:

| | | | | | | | | | | | | | | | | | | | | | | | |
|---|---|---|---|---|---|---|---|---|----|----|----|----|----|----|----|----|----|----|----|----|----|----|----|
| 1 | 2 | 3 | 4 | 5 | 6 | 7 | 8 | 9 | 10 | 11 | 12 | 13 | 14 | 15 | 16 | 17 | 18 | 19 | 20 | 21 | 22 | 23 | 24 |
|---|---|---|---|---|---|---|---|---|----|----|----|----|----|----|----|----|----|----|----|----|----|----|----|
- View:

| | | | | | | | | | | | | | | | | | | | | | | | |
|--|--|--|--|--|--|--|--|--|--|--|--|--|--|--|--|--|--|--|--|--|--|--|--|
| | | | | | | | | | | | | | | | | | | | | | | | |
|--|--|--|--|--|--|--|--|--|--|--|--|--|--|--|--|--|--|--|--|--|--|--|--|
- To read: 7 MPI_INT
- File+view:

| | | | | | | | | | | | | | | | | | | | | | | | |
|---|---|---|---|---|---|---|---|---|----|----|----|----|----|----|----|----|----|----|----|----|----|----|----|
| 1 | 2 | 3 | 4 | 5 | 6 | 7 | 8 | 9 | 10 | 11 | 12 | 13 | 14 | 15 | 16 | 17 | 18 | 19 | 20 | 21 | 22 | 23 | 24 |
|---|---|---|---|---|---|---|---|---|----|----|----|----|----|----|----|----|----|----|----|----|----|----|----|

individual reading example

```
/*filetype from previous example "sharing a file"*/
```

```
MPI_Type_create_resized(datatmp, lower_bound, extent, &filetype);
```

```
MPI_Type_commit(&filetype);
```

```
Int buf[7];
```

```
MPI_File_read(fh, &buf, 7, MPI_INT, MPI_STATUS_IGNORE);
```

- File:

| | | | | | | | | | | | | | | | | | | | | | | | |
|---|---|---|---|---|---|---|---|---|----|----|----|----|----|----|----|----|----|----|----|----|----|----|----|
| 1 | 2 | 3 | 4 | 5 | 6 | 7 | 8 | 9 | 10 | 11 | 12 | 13 | 14 | 15 | 16 | 17 | 18 | 19 | 20 | 21 | 22 | 23 | 24 |
|---|---|---|---|---|---|---|---|---|----|----|----|----|----|----|----|----|----|----|----|----|----|----|----|
- View:

| | | | | | | | | | | | | | | | | | | | | | | | |
|--|--|--|--|--|--|--|--|--|--|--|--|--|--|--|--|--|--|--|--|--|--|--|--|
| | | | | | | | | | | | | | | | | | | | | | | | |
|--|--|--|--|--|--|--|--|--|--|--|--|--|--|--|--|--|--|--|--|--|--|--|--|
- To read: 7 MPI_INT
- File+view:

| | | | | | | | | | | | | | | | | | | | | | | | |
|---|---|---|---|---|---|---|---|---|----|----|----|----|----|----|----|----|----|----|----|----|----|----|----|
| 1 | 2 | 3 | 4 | 5 | 6 | 7 | 8 | 9 | 10 | 11 | 12 | 13 | 14 | 15 | 16 | 17 | 18 | 19 | 20 | 21 | 22 | 23 | 24 |
|---|---|---|---|---|---|---|---|---|----|----|----|----|----|----|----|----|----|----|----|----|----|----|----|
- buffer:

| | | | | | | |
|--|--|--|--|--|--|--|
| | | | | | | |
|--|--|--|--|--|--|--|

individual reading example

```
/*filetype from previous example "sharing a file"*/
```

```
MPI_Type_create_resized(datatmp, lower_bound, extent, &filetype);
```

```
MPI_Type_commit(&filetype);
```

```
Int buf[7];
```

```
MPI_File_read(fh, &buf, 7, MPI_INT, MPI_STATUS_IGNORE);
```

- File:

| | | | | | | | | | | | | | | | | | | | | | | | |
|---|---|---|---|---|---|---|---|---|----|----|----|----|----|----|----|----|----|----|----|----|----|----|----|
| 1 | 2 | 3 | 4 | 5 | 6 | 7 | 8 | 9 | 10 | 11 | 12 | 13 | 14 | 15 | 16 | 17 | 18 | 19 | 20 | 21 | 22 | 23 | 24 |
|---|---|---|---|---|---|---|---|---|----|----|----|----|----|----|----|----|----|----|----|----|----|----|----|
- View:

| | | | | | | | | | | | | | | | | | | | | | | | |
|--|--|--|--|--|--|--|--|--|--|--|--|--|--|--|--|--|--|--|--|--|--|--|--|
| | | | | | | | | | | | | | | | | | | | | | | | |
|--|--|--|--|--|--|--|--|--|--|--|--|--|--|--|--|--|--|--|--|--|--|--|--|
- To read: 7 MPI_INT
- File+view:

| | | | | | | | | | | | | | | | | | | | | | | | |
|---|---|---|---|---|---|---|---|---|----|----|----|----|----|----|----|----|----|----|----|----|----|----|----|
| 1 | 2 | 3 | 4 | 5 | 6 | 7 | 8 | 9 | 10 | 11 | 12 | 13 | 14 | 15 | 16 | 17 | 18 | 19 | 20 | 21 | 22 | 23 | 24 |
|---|---|---|---|---|---|---|---|---|----|----|----|----|----|----|----|----|----|----|----|----|----|----|----|
- buffer:

| | | | | | | |
|---|--|--|--|--|--|--|
| 2 | | | | | | |
|---|--|--|--|--|--|--|

individual reading example

```
/*filetype from previous example "sharing a file"*/
```

```
MPI_Type_create_resized(datatmp, lower_bound, extent, &filetype);
```

```
MPI_Type_commit(&filetype);
```

```
Int buf[7];
```

```
MPI_File_read(fh, &buf, 7, MPI_INT, MPI_STATUS_IGNORE);
```

- File:

| | | | | | | | | | | | | | | | | | | | | | | | |
|---|---|---|---|---|---|---|---|---|----|----|----|----|----|----|----|----|----|----|----|----|----|----|----|
| 1 | 2 | 3 | 4 | 5 | 6 | 7 | 8 | 9 | 10 | 11 | 12 | 13 | 14 | 15 | 16 | 17 | 18 | 19 | 20 | 21 | 22 | 23 | 24 |
|---|---|---|---|---|---|---|---|---|----|----|----|----|----|----|----|----|----|----|----|----|----|----|----|
- View:

| | | | | | | | | | | | | | | | | | | | | | | | |
|--|--|--|--|--|--|--|--|--|--|--|--|--|--|--|--|--|--|--|--|--|--|--|--|
| | | | | | | | | | | | | | | | | | | | | | | | |
|--|--|--|--|--|--|--|--|--|--|--|--|--|--|--|--|--|--|--|--|--|--|--|--|
- To read: 7 MPI_INT
- File+view:

| | | | | | | | | | | | | | | | | | | | | | | | |
|---|---|---|---|---|---|---|---|---|----|----|----|----|----|----|----|----|----|----|----|----|----|----|----|
| 1 | 2 | 3 | 4 | 5 | 6 | 7 | 8 | 9 | 10 | 11 | 12 | 13 | 14 | 15 | 16 | 17 | 18 | 19 | 20 | 21 | 22 | 23 | 24 |
|---|---|---|---|---|---|---|---|---|----|----|----|----|----|----|----|----|----|----|----|----|----|----|----|
- buffer:

| | | | | | | |
|---|---|--|--|--|--|--|
| 2 | 3 | | | | | |
|---|---|--|--|--|--|--|

individual reading example

```
/*filetype from previous example "sharing a file"*/
```

```
MPI_Type_create_resized(datatmp, lower_bound, extent, &filetype);
```

```
MPI_Type_commit(&filetype);
```

```
Int buf[7];
```

```
MPI_File_read(fh, &buf, 7, MPI_INT, MPI_STATUS_IGNORE);
```

- File:

| | | | | | | | | | | | | | | | | | | | | | | | |
|---|---|---|---|---|---|---|---|---|----|----|----|----|----|----|----|----|----|----|----|----|----|----|----|
| 1 | 2 | 3 | 4 | 5 | 6 | 7 | 8 | 9 | 10 | 11 | 12 | 13 | 14 | 15 | 16 | 17 | 18 | 19 | 20 | 21 | 22 | 23 | 24 |
|---|---|---|---|---|---|---|---|---|----|----|----|----|----|----|----|----|----|----|----|----|----|----|----|
- View:

| | | | | | | | | | | | | | | | | | | | | | | | |
|--|--|--|--|--|--|--|--|--|--|--|--|--|--|--|--|--|--|--|--|--|--|--|--|
| | | | | | | | | | | | | | | | | | | | | | | | |
|--|--|--|--|--|--|--|--|--|--|--|--|--|--|--|--|--|--|--|--|--|--|--|--|
- To read: 7 MPI_INT
- File+view:

| | | | | | | | | | | | | | | | | | | | | | | | |
|---|---|---|---|---|---|---|---|---|----|----|----|----|----|----|----|----|----|----|----|----|----|----|----|
| 1 | 2 | 3 | 4 | 5 | 6 | 7 | 8 | 9 | 10 | 11 | 12 | 13 | 14 | 15 | 16 | 17 | 18 | 19 | 20 | 21 | 22 | 23 | 24 |
|---|---|---|---|---|---|---|---|---|----|----|----|----|----|----|----|----|----|----|----|----|----|----|----|
- buffer:

| | | | | | | |
|---|---|---|--|--|--|--|
| 2 | 3 | 7 | | | | |
|---|---|---|--|--|--|--|

individual reading example

```
/*filetype from previous example "sharing a file"*/
```

```
MPI_Type_create_resized(datatmp, lower_bound, extent, &filetype);
```

```
MPI_Type_commit(&filetype);
```

```
Int buf[7];
```

```
MPI_File_read(fh, &buf, 7, MPI_INT, MPI_STATUS_IGNORE);
```

- File:

| | | | | | | | | | | | | | | | | | | | | | | | |
|---|---|---|---|---|---|---|---|---|----|----|----|----|----|----|----|----|----|----|----|----|----|----|----|
| 1 | 2 | 3 | 4 | 5 | 6 | 7 | 8 | 9 | 10 | 11 | 12 | 13 | 14 | 15 | 16 | 17 | 18 | 19 | 20 | 21 | 22 | 23 | 24 |
|---|---|---|---|---|---|---|---|---|----|----|----|----|----|----|----|----|----|----|----|----|----|----|----|
- View:

| | | | | | | | | | | | | | | | | | | | | | | | |
|--|--|--|--|--|--|--|--|--|--|--|--|--|--|--|--|--|--|--|--|--|--|--|--|
| | | | | | | | | | | | | | | | | | | | | | | | |
|--|--|--|--|--|--|--|--|--|--|--|--|--|--|--|--|--|--|--|--|--|--|--|--|
- To read: 7 MPI_INT
- File+view:

| | | | | | | | | | | | | | | | | | | | | | | | |
|---|---|---|---|---|---|---|---|---|----|----|----|----|----|----|----|----|----|----|----|----|----|----|----|
| 1 | 2 | 3 | 4 | 5 | 6 | 7 | 8 | 9 | 10 | 11 | 12 | 13 | 14 | 15 | 16 | 17 | 18 | 19 | 20 | 21 | 22 | 23 | 24 |
|---|---|---|---|---|---|---|---|---|----|----|----|----|----|----|----|----|----|----|----|----|----|----|----|
- buffer:

| | | | | | | |
|---|---|---|---|--|--|--|
| 2 | 3 | 7 | 8 | | | |
|---|---|---|---|--|--|--|

individual reading example

/*filetype from previous example "sharing a file"*/

```
MPI_Type_create_resized(datatmp, lower_bound, extent, &filetype);
```

```
MPI_Type_commit(&filetype);
```

```
Int buf[7];
```

```
MPI_File_read(fh, &buf, 7, MPI_INT, MPI_STATUS_IGNORE);
```

- File:

| | | | | | | | | | | | | | | | | | | | | | | | |
|---|---|---|---|---|---|---|---|---|----|----|----|----|----|----|----|----|----|----|----|----|----|----|----|
| 1 | 2 | 3 | 4 | 5 | 6 | 7 | 8 | 9 | 10 | 11 | 12 | 13 | 14 | 15 | 16 | 17 | 18 | 19 | 20 | 21 | 22 | 23 | 24 |
|---|---|---|---|---|---|---|---|---|----|----|----|----|----|----|----|----|----|----|----|----|----|----|----|
- View:

| | | | | | | | | | | | | | | | | | | | | | | | |
|--|--|--|--|--|--|--|--|--|--|--|--|--|--|--|--|--|--|--|--|--|--|--|--|
| | | | | | | | | | | | | | | | | | | | | | | | |
|--|--|--|--|--|--|--|--|--|--|--|--|--|--|--|--|--|--|--|--|--|--|--|--|
- To read: 7 MPI_INT
- File+view:

| | | | | | | | | | | | | | | | | | | | | | | | |
|---|---|---|---|---|---|---|---|---|----|----|----|----|----|----|----|----|----|----|----|----|----|----|----|
| 1 | 2 | 3 | 4 | 5 | 6 | 7 | 8 | 9 | 10 | 11 | 12 | 13 | 14 | 15 | 16 | 17 | 18 | 19 | 20 | 21 | 22 | 23 | 24 |
|---|---|---|---|---|---|---|---|---|----|----|----|----|----|----|----|----|----|----|----|----|----|----|----|
- buffer:

| | | | | | | |
|---|---|---|---|----|----|----|
| 2 | 3 | 7 | 8 | 13 | 14 | 19 |
|---|---|---|---|----|----|----|

Individual write

- `MPI_File_write(MPI_File fh, const void *buf, int count, MPI_Datatype datatype, MPI_Status *status);`
 - INOUT fh file handle (handle)
 - IN buf initial address of buffer (choice)
 - IN count number of elements in buffer (integer)
 - IN datatype datatype of each buffer element (handle)
 - OUT status status object (Status)
- Individual function
- *count* and *datatype* specifies the number of elements and the type of elements to write from buffer *buf*
 - Much like in a `MPI_Send` function
- Write contiguous elements according to the view associated with the file

individual writing example



```
/*filetype from previous example "sharing a file"*/
```

```
MPI_Type_create_resized(datatmp, lower_bound, extent, &filetype);
```

```
MPI_Type_commit(&filetype);
```

```
Int buf[10] = {1,2,3,4,5,6,7,8,9,10};
```

```
MPI_File_write(fh, &buf, 10, MPI_INT, MPI_STATUS_IGNORE);
```

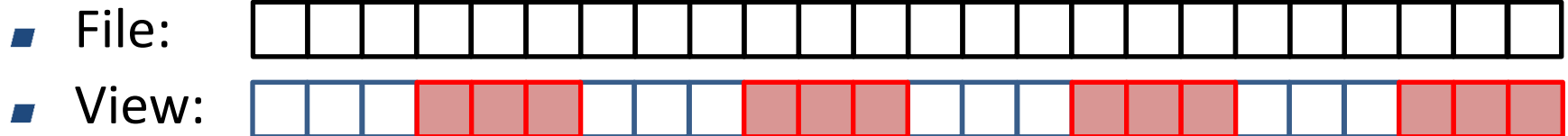

individual writing example



/*filetype from previous example "sharing a file"*/

```
MPI_Type_create_resized(datatmp, lower_bound, extent, &filetype);
```

```
MPI_Type_commit(&filetype);
```

```
Int buf[10] = {1,2,3,4,5,6,7,8,9,10};
```

```
MPI_File_write(fh, &buf, 10, MPI_INT, MPI_STATUS_IGNORE);
```

- File: 
- View: 
- To read: 10 MPI_INT

individual writing example

```
/*filetype from previous example "sharing a file"*/
```

```
MPI_Type_create_resized(datatmp, lower_bound, extent, &filetype);
```

```
MPI_Type_commit(&filetype);
```

```
Int buf[10] = {1,2,3,4,5,6,7,8,9,10};
```

```
MPI_File_write(fh, &buf, 10, MPI_INT, MPI_STATUS_IGNORE);
```

- File:

| | | | | | | | | | | | | | | | | | | | | |
|--|--|--|--|--|--|--|--|--|--|--|--|--|--|--|--|--|--|--|--|--|
| | | | | | | | | | | | | | | | | | | | | |
|--|--|--|--|--|--|--|--|--|--|--|--|--|--|--|--|--|--|--|--|--|
- View:

| | | | | | | | | | | | | | | | | | | | | |
|--|--|--|--|--|--|--|--|--|--|--|--|--|--|--|--|--|--|--|--|--|
| | | | | | | | | | | | | | | | | | | | | |
|--|--|--|--|--|--|--|--|--|--|--|--|--|--|--|--|--|--|--|--|--|
- To read: 10 MPI_INT
- buffer:

| | | | | | | | | | |
|---|---|---|---|---|---|---|---|---|----|
| 1 | 2 | 3 | 4 | 5 | 6 | 7 | 8 | 9 | 10 |
|---|---|---|---|---|---|---|---|---|----|

individual writing example



`/*filetype from previous example "sharing a file"*/`

```
MPI_Type_create_resized(datatmp, lower_bound, extent, &filetype);
```

```
MPI_Type_commit(&filetype);
```

```
Int buf[10] = {1,2,3,4,5,6,7,8,9,10};
```

```
MPI_File_write(fh, &buf, 10, MPI_INT, MPI_STATUS_IGNORE);
```

- File: 
- View: 
- To read: 10 MPI_INT
- buffer:

| | | | | | | | | | |
|---|---|---|---|---|---|---|---|---|----|
| 1 | 2 | 3 | 4 | 5 | 6 | 7 | 8 | 9 | 10 |
|---|---|---|---|---|---|---|---|---|----|
- File: 

individual writing example

```
/*filetype from previous example "sharing a file"*/
```

```
MPI_Type_create_resized(datatmp, lower_bound, extent, &filetype);
```

```
MPI_Type_commit(&filetype);
```

```
Int buf[10] = {1,2,3,4,5,6,7,8,9,10};
```

```
MPI_File_write(fh, &buf, 10, MPI_INT, MPI_STATUS_IGNORE);
```

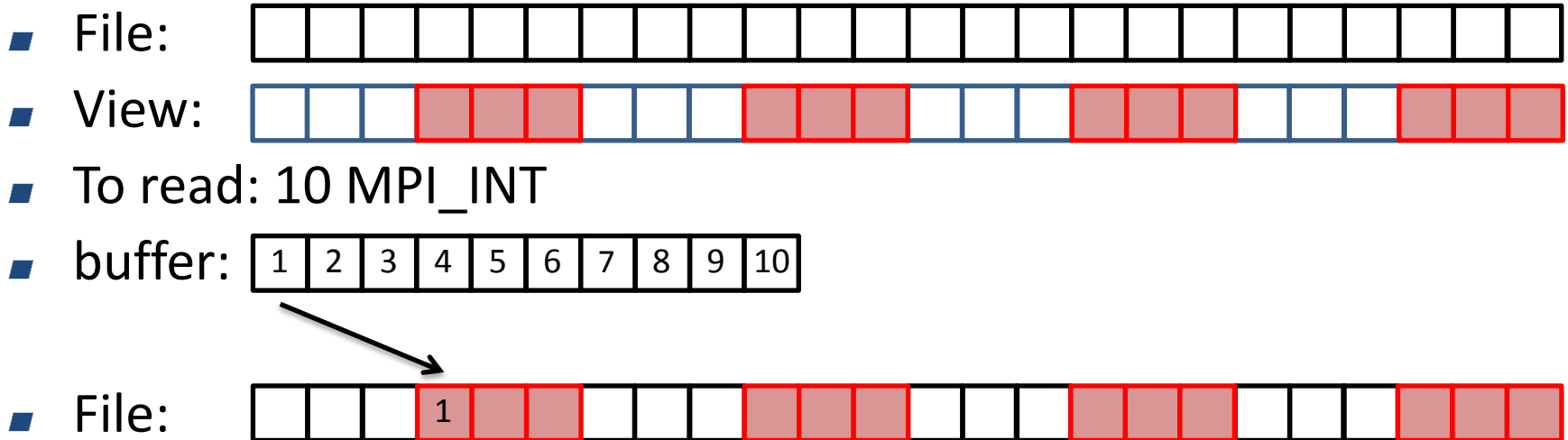

individual writing example

```
/*filetype from previous example "sharing a file"*/
```

```
MPI_Type_create_resized(datatmp, lower_bound, extent, &filetype);
```

```
MPI_Type_commit(&filetype);
```

```
Int buf[10] = {1,2,3,4,5,6,7,8,9,10};
```

```
MPI_File_write(fh, &buf, 10, MPI_INT, MPI_STATUS_IGNORE);
```

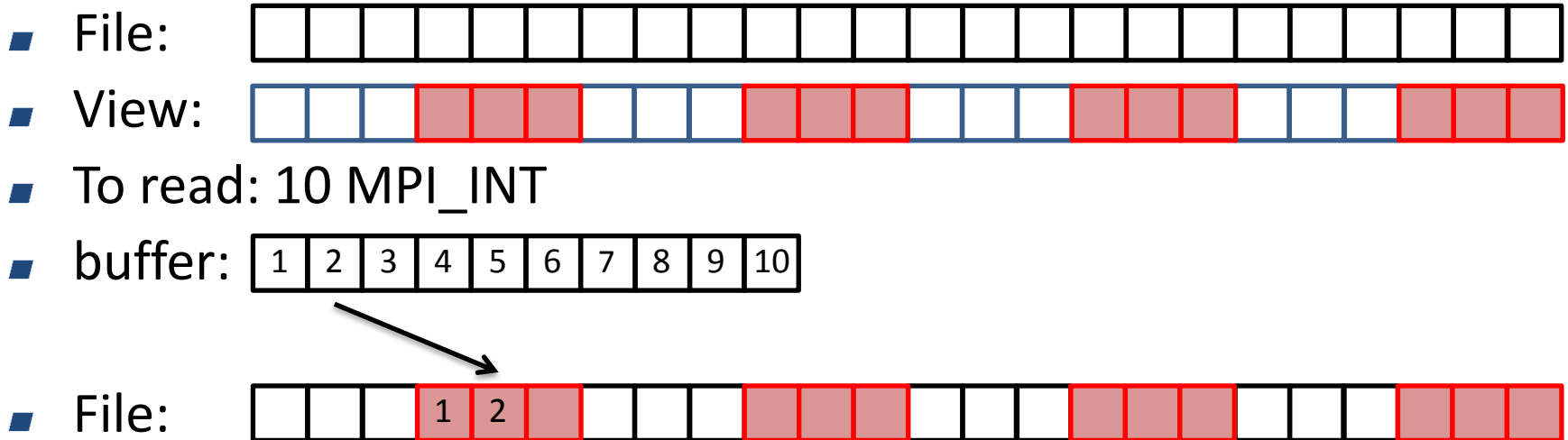

individual writing example

```
/*filetype from previous example "sharing a file"*/
```

```
MPI_Type_create_resized(datatmp, lower_bound, extent, &filetype);
```

```
MPI_Type_commit(&filetype);
```

```
Int buf[10] = {1,2,3,4,5,6,7,8,9,10};
```

```
MPI_File_write(fh, &buf, 10, MPI_INT, MPI_STATUS_IGNORE);
```

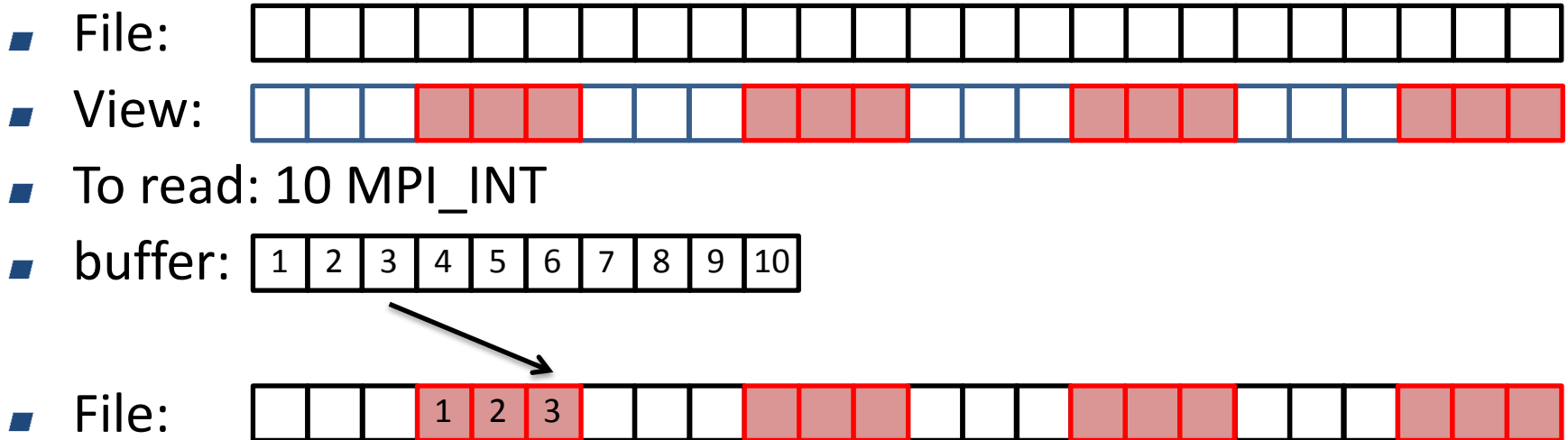

individual writing example

```
/*filetype from previous example "sharing a file"*/
```

```
MPI_Type_create_resized(datatmp, lower_bound, extent, &filetype);
```

```
MPI_Type_commit(&filetype);
```

```
Int buf[10] = {1,2,3,4,5,6,7,8,9,10};
```

```
MPI_File_write(fh, &buf, 10, MPI_INT, MPI_STATUS_IGNORE);
```

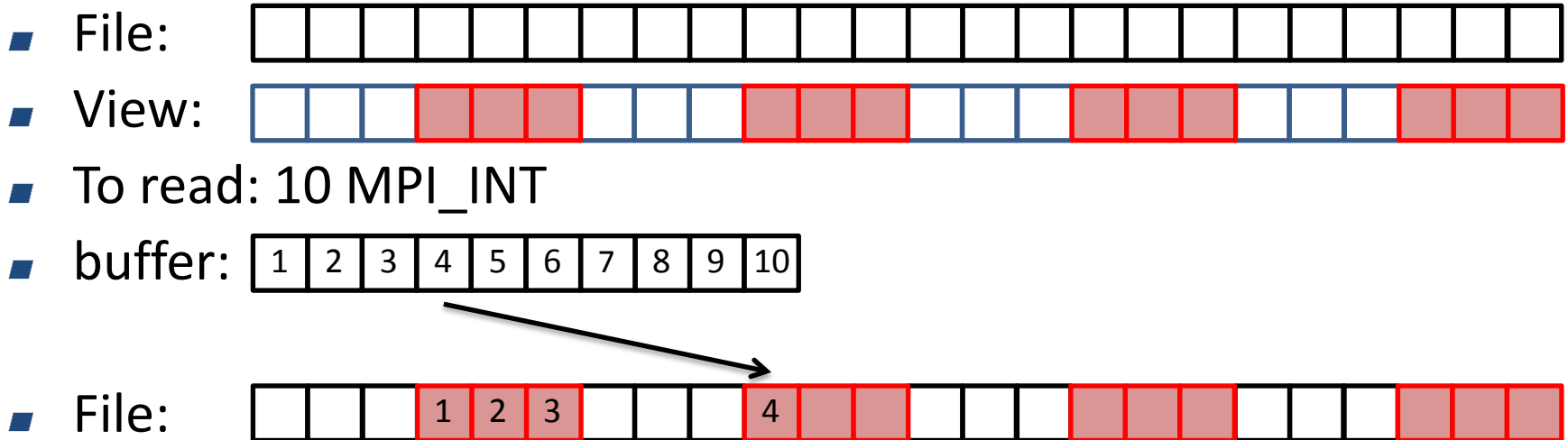

individual writing example

```
/*filetype from previous example "sharing a file"*/
```

```
MPI_Type_create_resized(datatmp, lower_bound, extent, &filetype);
```

```
MPI_Type_commit(&filetype);
```

```
Int buf[10] = {1,2,3,4,5,6,7,8,9,10};
```

```
MPI_File_write(fh, &buf, 10, MPI_INT, MPI_STATUS_IGNORE);
```

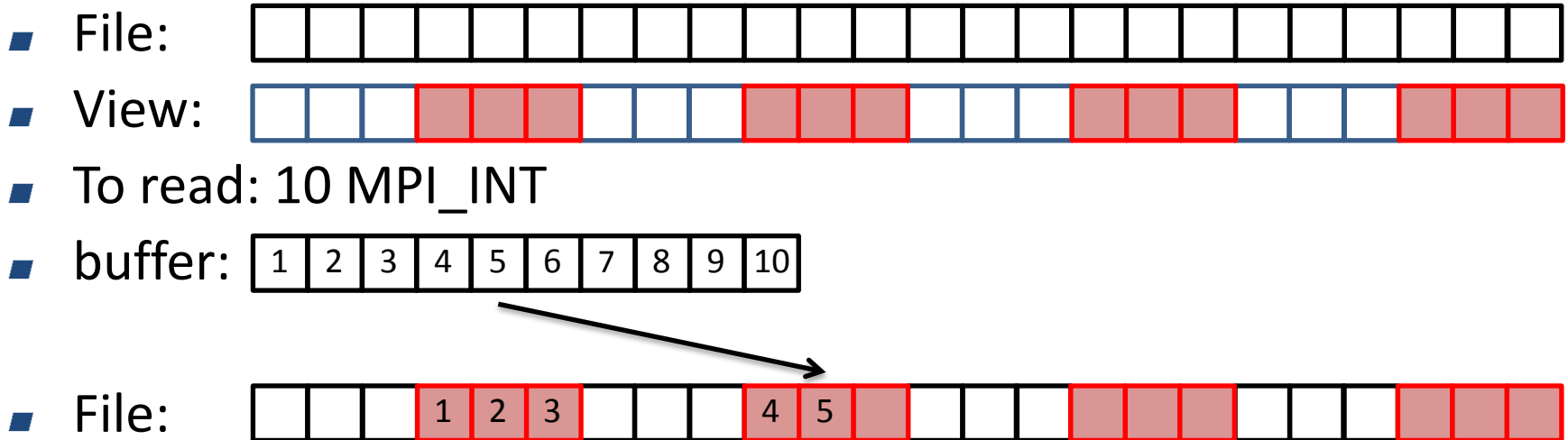

Collective read

- `MPI_File_read_all(MPI_File fh, void *buf, int count, MPI_Datatype datatype, MPI_Status *status);`
 - INOUT fh file handle (handle)
 - OUT buf initial address of buffer (choice)
 - IN count number of elements in buffer (integer)
 - IN datatype datatype of each buffer element (handle)
 - OUT status status object (Status)
- Collective function
 - Each process must reference the same file
- *count* and *datatype* specifies the number of elements and the type of elements to read and put in buffer *buf*
 - Much like in a `MPI_Recv` function
- Read contiguous elements according to the each process's view associated with the file

Collective reading example





```
/*filetype from previous example "sharing a file"*/
```

```
MPI_Type_create_resized(datatmp, lower_bound, extent, &filetype);
```

```
MPI_Type_commit(&filetype);
```

```
Int buf...;
```

```
MPI_File_write(fh, &buf, count, MPI_INT, MPI_STATUS_IGNORE);
```

- Process 0 filetype:  count=4
- Process 1 filetype:  count=5
- Process 2 filetype:  count=10
- File:

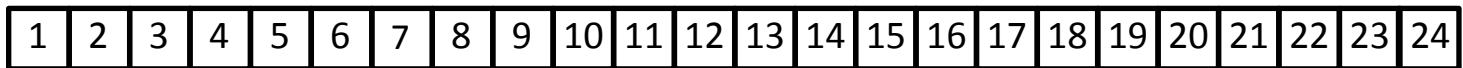

- bufs



Collective reading example



```
/*filetype from previous example "sharing a file"*/
```

```
MPI_Type_create_resized(datatmp, lower_bound, extent, &filetype);
```

```
MPI_Type_commit(&filetype);
```

```
Int buf...;
```

```
MPI_File_write(fh, &buf, count, MPI_INT, MPI_STATUS_IGNORE);
```

- Process 0 filetype:  count=4
- Process 1 filetype:  count=5
- Process 2 filetype:  count=10
- File:

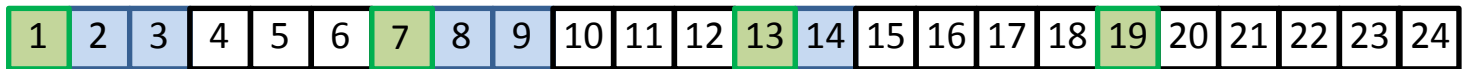

- bufs

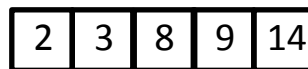
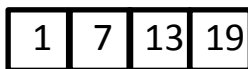

Collective reading example



```
/*filetype from previous example "sharing a file"*/
```

```
MPI_Type_create_resized(datatmp, lower_bound, extent, &filetype);
```

```
MPI_Type_commit(&filetype);
```

```
Int buf...;
```

```
MPI_File_write(fh, &buf, count, MPI_INT, MPI_STATUS_IGNORE);
```

- Process 0 filetype:  count=4
- Process 1 filetype:  count=5
- Process 2 filetype:  count=10
- File:



- bufs

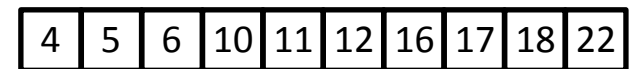
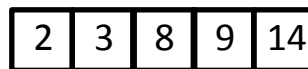
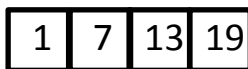

Collective write

- `MPI_File_write_all(MPI_File fh, const void *buf, int count, MPI_Datatype datatype, MPI_Status *status);`
 - INOUT fh file handle (handle)
 - IN buf initial address of buffer (choice)
 - IN count number of elements in buffer (integer)
 - IN datatype datatype of each buffer element (handle)
 - OUT status status object (Status)
- Collective function
 - Each process must reference the same file
- *count* and *datatype* specifies the number of elements and the type of elements to write from buffer *buf*
 - Much like in a `MPI_Send` function
- Write contiguous elements according to the each process's view associated with the file

Collective reading example



```
/*filetype from previous example "sharing a file"*/
```

```
MPI_Type_create_resized(datatmp, lower_bound, extent, &filetype);
```

```
MPI_Type_commit(&filetype);
```

```
Int buf...;
```

```
MPI_File_write(fh, &buf, count, MPI_INT, MPI_STATUS_IGNORE);
```

- Process 0 filetype:  count=4
- Process 1 filetype:  count=5
- Process 2 filetype:  count=10

- bufs:

| | | | |
|---|---|---|---|
| 1 | 2 | 3 | 4 |
|---|---|---|---|

| | | | | |
|----|----|----|----|----|
| 20 | 21 | 22 | 23 | 24 |
|----|----|----|----|----|

| | | | | | | |
|----|----|----|----|----|----|----|
| 40 | 41 | 42 | 43 | 44 | 45 | 46 |
|----|----|----|----|----|----|----|

- File

| | | | | | | | | | | | | | | | | | | | | | | |
|---|----|----|--|--|--|---|----|----|--|--|--|---|----|--|--|--|--|---|--|--|--|--|
| 1 | 20 | 21 | | | | 2 | 22 | 23 | | | | 3 | 24 | | | | | 4 | | | | |
|---|----|----|--|--|--|---|----|----|--|--|--|---|----|--|--|--|--|---|--|--|--|--|

Collective reading example



```
/*filetype from previous example "sharing a file"*/
```

```
MPI_Type_create_resized(datatmp, lower_bound, extent, &filetype);
```

```
MPI_Type_commit(&filetype);
```

```
Int buf...;
```

```
MPI_File_write(fh, &buf, count, MPI_INT, MPI_STATUS_IGNORE);
```

- Process 0 filetype:  count=4
- Process 1 filetype:  count=5
- Process 2 filetype:  count=10

- bufs:

| | | | |
|---|---|---|---|
| 1 | 2 | 3 | 4 |
|---|---|---|---|

| | | | | |
|----|----|----|----|----|
| 20 | 21 | 22 | 23 | 24 |
|----|----|----|----|----|

| | | | | | | |
|----|----|----|----|----|----|----|
| 40 | 41 | 42 | 43 | 44 | 45 | 46 |
|----|----|----|----|----|----|----|

- File

| | | | | | | | | | | | | | | | | | | | | | | | |
|---|----|----|--|----|----|---|----|----|--|----|----|---|----|--|--|----|----|---|--|--|--|----|--|
| 1 | 20 | 21 | | 40 | 41 | 2 | 22 | 23 | | 42 | 43 | 3 | 24 | | | 44 | 45 | 4 | | | | 46 | |
|---|----|----|--|----|----|---|----|----|--|----|----|---|----|--|--|----|----|---|--|--|--|----|--|

Collective reading example



```
/*filetype from previous example "sharing a file"*/
```

```
MPI_Type_create_resized(datatmp, lower_bound, extent, &filetype);
```

```
MPI_Type_commit(&filetype);
```

```
Int buf...;
```

```
MPI_File_write(fh, &buf, count, MPI_INT, MPI_STATUS_IGNORE);
```

- Process 0 filetype:  count=4
- Process 1 filetype:  count=5
- Process 2 filetype:  count=10

- bufs:

| | | | |
|---|---|---|---|
| 1 | 2 | 3 | 4 |
|---|---|---|---|

| | | | | |
|----|----|----|----|----|
| 20 | 21 | 22 | 23 | 24 |
|----|----|----|----|----|

| | | | | | | |
|----|----|----|----|----|----|----|
| 40 | 41 | 42 | 43 | 44 | 45 | 46 |
|----|----|----|----|----|----|----|

- File

| | | | | | | | | | | | | | | | | | | | | | | |
|---|----|----|--|----|----|---|----|----|--|----|----|---|----|--|--|----|----|---|--|--|--|----|
| 1 | 20 | 21 | | 40 | 41 | 2 | 22 | 23 | | 42 | 43 | 3 | 24 | | | 44 | 45 | 4 | | | | 46 |
|---|----|----|--|----|----|---|----|----|--|----|----|---|----|--|--|----|----|---|--|--|--|----|

ADVANCED MPI I/O CALLS

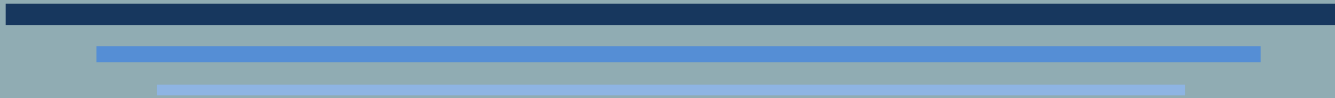

Shared pointer routine



- The previous functions have individual file pointers
 - Each process has its own file pointer locating where to write in the file
 - The file pointer is updated to the next location each time a data is read/written
- The same functions working on a shared file pointer exist
 - The file pointer is shared among all processes involved in the file opening
 - A read/write in the file update the pointer for all processes
 - Multiple parallel calls to shared pointer routine are serialized
- `/!\` all processes involved must use the same file view
- Collective calls are ordered according to their rank
- Same function call + `_shared` suffix

Individual file pointer individual read

- 
- `MPI_File_read(MPI_File fh, void *buf, int count, MPI_Datatype datatype, MPI_Status *status);`
 - INOUT fh file handle (handle)
 - OUT buf initial address of buffer to put read data
 - IN count number of elements in buffer (integer)
 - IN datatype datatype of each buffer element (handle)
 - OUT status status object (Status)

Shared file pointer individual read



- `MPI_File_read_shared(MPI_File fh, void *buf, int count, MPI_Datatype datatype, MPI_Status *status);`
 - INOUT fh file handle (handle)
 - OUT buf initial address of buffer (choice)
 - IN count number of elements in buffer (integer)
 - IN datatype datatype of each buffer element (handle)
 - OUT status status object (Status)

Shared file pointer individual write



- `MPI_File_write_shared(MPI_File fh, const void *buf, int count, MPI_Datatype datatype, MPI_Status *status);`
 - INOUT fh file handle (handle)
 - IN buf initial address of buffer (choice)
 - IN count number of elements in buffer (integer)
 - IN datatype datatype of each buffer element (handle)
 - OUT status status object (Status)

Shared file pointer collective read

- `MPI_File_read_ordered(MPI_File fh, void *buf, int count, MPI_Datatype datatype, MPI_Status *status);`
 - INOUT fh file handle (handle)
 - OUT buf initial address of buffer (choice)
 - IN count number of elements in buffer (integer)
 - IN datatype datatype of each buffer element (handle)
 - OUT status status object (Status)
- Collective version of `MPI_File_read_shared`

Shared file pointer collective write

- `MPI_File_write_ordered(MPI_File fh, const void *buf, int count, MPI_Datatype datatype, MPI_Status *status);`
 - INOUT fh file handle (handle)
 - IN buf initial address of buffer (choice)
 - IN count number of elements in buffer (integer)
 - IN datatype datatype of each buffer element (handle)
 - OUT status status object (Status)
- Collective version of `MPI_File_write_shared`

Data access with explicit offset



- The previous functions use file pointers to “know” the offset where to write
- Read/write and collective functions also exist with explicit offset to specify
 - No file pointer is used nor updated
 - Offset is explicitly given as an argument of the function
- Same function call + *_at* suffix

Individual file pointer individual read



- `MPI_File_read(MPI_File fh, void *buf, int count, MPI_Datatype datatype, MPI_Status *status);`
 - INOUT fh file handle (handle)
 - OUT buf initial address of buffer to put read data
 - IN count number of elements in buffer (integer)
 - IN datatype datatype of each buffer element (handle)
 - OUT status status object (Status)

Explicit offset individual read



- `MPI_File_read_at(MPI_File fh, void *buf, int count, MPI_Datatype datatype, MPI_Status *status);`
 - IN fh file handle (handle)
 - IN offset file offset integer)
 - OUT buf initial address of buffer (choice)
 - IN count number of elements in buffer (integer)
 - IN datatype datatype of each buffer element (handle)
 - OUT status status object (Status)

Explicit offset individual read

- `MPI_File_read_at(MPI_File fh, void *buf, int count, MPI_Datatype datatype, MPI_Status *status);`
 - **IN** **fh** **file handle (handle)**
 - **IN** **offset** **file offset integer)**
 - **OUT** **buf** initial address of buffer (choice)
 - **IN** **count** number of elements in buffer (integer)
 - **IN** **datatype** datatype of each buffer element (handle)
 - **OUT** **status** status object (Status)

- *Fh* is not out anymore because no file pointer is updated

- *Offset* gives the beginning where to read data in the file

Explicit offset individual write



- `MPI_File_write_at(MPI_File fh, void *buf, int count, MPI_Datatype datatype, MPI_Status *status);`
 - IN fh file handle (handle)
 - IN offset file offset integer)
 - OUT buf initial address of buffer (choice)
 - IN count number of elements in buffer (integer)
 - IN datatype datatype of each buffer element (handle)
 - OUT status status object (Status)

Explicit offset collective read

- `MPI_File_read_at_all(MPI_File fh, void *buf, int count, MPI_Datatype datatype, MPI_Status *status);`
 - IN fh file handle (handle)
 - IN offset file offset integer)
 - OUT buf initial address of buffer (choice)
 - IN count number of elements in buffer (integer)
 - IN datatype datatype of each buffer element (handle)
 - OUT status status object (Status)
- Collective version of `MPI_File_read_at`

Explicit offset collective write

- `MPI_File_write_at_all(MPI_File fh, void *buf, int count, MPI_Datatype datatype, MPI_Status *status);`
 - IN fh file handle (handle)
 - IN offset file offset integer)
 - OUT buf initial address of buffer (choice)
 - IN count number of elements in buffer (integer)
 - IN datatype datatype of each buffer element (handle)
 - OUT status status object (Status)

- Collective version of `MPI_File_write_at`

Non-blocking routines



- All routines exist in non-blocking versions with the usual semantics
 - Function calls begin with an “I”
 - A request is given in argument, to be later passed to completion calls
- Another non-blocking semantics exist for MPI I/O collective calls: split call
 - A single collective operation is split in two: a begin and an end function
 - The operation is initiated by the `***_begin` call (much like `Iread_all` call)
 - The completion call is done by the `***_end` call (much like `wait` call)
- Rules to use split calls
 - No more than one active split collective at any moment
 - Begin calls are collective
 - No collective I/O are permitted within an active split collective access

DATA REPRESENTATION

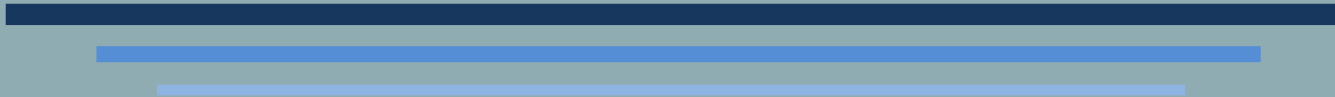

How to write the data?



- So far, we have seen functions allowing to read and write data from files
- But what is the binary representation of these data?
 - Big indian? Little indian?
 - 16bits? 32bits? 64bits?
- If it is the binary representation of the current computer, the file may not be portable across platforms
- If it is a fixed representation, need to translate chosen representation to current computer representation

3 data representations in MPI I/O



- Native
 - Data in this representation is stored in a file exactly as it is in memory
 - data precision and I/O performance are not lost in type conversions with a purely homogeneous environment
 - Files are not portable across platforms
- internal
 - This data representation can be used for I/O operations in a homogeneous or heterogeneous environment; the implementation will perform type conversions if necessary.
 - Portable across platforms, but not across MPI implementations
- External32
 - read and write operations convert all data from and to the external32 representation completely defined in MPI I/O (Section 13.5.2)
 - Portable across platforms and MPI implementations
 - May be less performant due to all the conversions